

OWNER'S/
OPERATOR'S
MANUAL

MODEL NO.'s

PSS-620

PSS-720

PSHD-665

PSHD-765

PSHD-865

 **CAUTION**

For Safe Operation
Read Rules And
Instructions Carefully

SI NO LEEINGLES, PIDA AYUDA
A AIGUIEN QUE SI LO LEA
PARA QUE LE TRADUZCA LAS
MEDIDAS DE SEGURIDAD.

Piranha

Skid Steer



Powered Rakes

Safety Instructions

Tractor Preparation

Operating Instructions

Assembly & Mounting

Maintenance

Repair Parts

 **CAUTION**

**THE FOLLOWING SAFETY PRECAUTIONS SHOULD BE THOROUGHLY UNDERSTOOD
BEFORE ATTEMPTING TO BEGIN ASSEMBLING THIS MACHINE**

1. Select an area for assembly that is clean and free of any debris which might cause persons working on the assembly to trip.
2. Do not lift heavy parts or assemblies. Use crane, jack, tackle, fork trucks or other mechanical devices.
3. Preview the assembly instructions in your operator's manual before proceeding further.
4. If the assembly instructions call for parts or assemblies to be blocked up, use only blocking material that is in good condition and is capable of handling the weight of the assembly to be blocked. Also insure that the blocking material is on a clean, dry surface.
5. Never put hands, or any part of body, under blocked up assemblies if at all possible.
6. After completing assembly, thoroughly inspect the machine to be sure that all nuts, bolts, hydraulic fittings or any other fastened assemblies have been thoroughly tightened.
7. Before operating the machine, thoroughly read the operation section of your operator's manual.
8. Before operating, read the maintenance section of your operator's manual to be sure that any parts requiring lubrication, such as gearboxes, are full, to avoid any possible damage.
9. **Before operating equipment – If you have any questions regarding the proper assembly or operation, contact your dealer or representative.**

TABLE OF CONTENTS

WARRANTY	2
SPECIFICATIONS.....	3
CHECK LISTS.....	4
SAFETY INFORMATION	5-16
SAFETY SIGNS	17
PREPARATION INSTRUCTIONS	18
ASSEMBLY/INSTALLATION	19-21
ADJUSTING FOR WORK	22-24
OPERATING INSTRUCTIONS.....	25-36
SERVICE & MAINTENANCE.....	37-40
TROUBLE-SHOOTING GUIDE	41-44
PARTS LISTS.....	45-60
OPTIONAL HYDRAULIC ANGLE KITS.....	31, 57-59
OPTIONAL SIDE SHIELD EXTENSION.....	29, 60
BOLT TORQUE CHART	61

SI NO LEEINGLES, PIDA AYUDA A AIGUIEN QUE SI LO LEA PARA QUE LE TRADUZCA LAS MEDIDAS DE SEGURIDAD.

STATEMENT OF POLICY

It is the policy of Worksaver, Inc. to improve its products where it is possible and practical to do so. Worksaver, Inc. reserves the right to make changes or improvements in design and construction at any time, without incurring the obligation to make these changes on previously manufactured units.

TO THE OWNER:

Read this manual before using your Skid Steer Mounted Powered Rake. This manual is provided to give you the necessary operating and maintenance instructions for keeping your powered rake in top operating condition. Please read this manual thoroughly. Understand what each control is for and how to use it. Observe all safety signs on the machine and noted throughout the manual for safe operation of implement. Keep this manual handy for ready reference.

Like all mechanical products, it will require cleaning and upkeep. Lubricate the Rake as specified.

Use only genuine Worksaver/Site Pro service parts. Substitute parts will void the warranty and may not meet standards required for safe and satisfactory operation. Record the model and serial number of your Powered Rake here:

Model: _____ Serial Number: _____

RETAIL CUSTOMER'S RESPONSIBILITY

It is the Retail Customer and/or Operator's responsibility to read the Operator's Manual, to operate, lubricate, maintain, and store the product in accordance with all instructions and safety procedures. Failure of the operator to read the Operator's Manual is a misuse of this equipment.

It is the Retail Customer and/or Operator's responsibility to inspect the product and to have any part(s) repaired or replaced when continued operation would cause damage or excessive wear to other parts or cause a safety hazard.

It is the Retail Customer's responsibility to deliver the product to the authorized Worksaver/Site Pro Dealer, from whom he purchased it, for service or replacement of defective parts which are covered by warranty. Repairs to be submitted for warranty consideration must be made within forty-five (45) days of failure.

It is the Retail Customer's responsibility for any cost incurred by the Dealer for traveling to or hauling of the product for the purpose of performing a warranty obligation or inspection.

LIMITED WARRANTY



Worksaver warrants its SitePro branded products to the original purchaser of any new “mini” skid steer mounted, hydraulic driven, Powered Rake (Models PSS-620/720, PSHD-665/765/865), that the equipment be free from defects in material and workmanship for a period of one (1) year, the warranty period begins on the first occurrence of (a) the date of initial purchase by an end-user (b) the date the product is first leased or rented and ends on the date that is twelve (12) months after the first occurrence.

Replacement or repair parts installed in the equipment covered by this warranty are warranted for ninety (90) days from the date of purchase of such part or to the expiration of the applicable new equipment warranty period, whichever occurs later.

Such parts shall be provided at no cost to the user during regular working hours. Worksaver reserves the right to inspect any equipment or parts which are claimed to have been defective in material or workmanship.

DISCLAIMER OF IMPLIED WARRANTIES & CONSEQUENTIAL DAMAGES

Worksaver's obligation under this warranty, to the extent allowed by law, is in lieu of all warranties, implied or expressed, including implied warranties of merchantability and fitness for a particular purpose and any liability for incidental and consequential damages with respect to the sale or use of the items warranted. Such incidental and consequential damages shall include but not be limited to: transportation charges other than normal freight charges; cost of installation other than cost approved by Worksaver; duty; taxes; charges for normal service or adjustments; loss of crops or any other loss of income; rental of substitute equipment, expenses due to loss, damage, detention or delay in the delivery of equipment or parts resulting from acts beyond the control of Worksaver.

THIS WARRANTY SHALL NOT APPLY:

1. To vendor items which carry their own warranties, such as hydraulic cylinders and hydraulic motor.
2. If the unit has been subjected to misapplication, abuse, misuse, negligence, fire or other accident.
3. If parts not made or supplied by Worksaver have been used in connection with the unit, if, in sole judgement of Worksaver such use affects its performance, stability, or reliability.
4. If the unit has been altered or repaired outside of an authorized Worksaver/SitePro dealership in a manner which, in the sole judgement of Worksaver affects its performance, stability or reliability.
5. To normal maintenance service and normal replacement items such as gearbox lubricant, hydraulic fluid, worn teeth, or to normal deterioration of such things as belts and exterior finish, due to use or exposure.
6. To expendable or wear items such as teeth, chains, sprockets, springs and other items that in the company's sole judgement is a wear item. Rotor assemblies are a wear item.

NO EMPLOYEE OR REPRESENTATIVE OF WORKSAVER IS AUTHORIZED TO CHANGE THIS WARRANTY IN ANY WAY OR GRANT ANY OTHER WARRANTY UNLESS SUCH CHANGE IS MADE IN WRITING AND SIGNED BY WORKSAVER'S SERVICE MANAGER, POST OFFICE BOX 100, LITCHFIELD, ILLINOIS 62056-0100.



SPECIFICATIONS

MINI SKID STEER POWERED RAKES

	PSS-620	PSS-720	PSHD-665	PSHD-765	PSHD-865
Non-Angled Working Width	72"	84"	72"	84"	96"
Angled Working Width	67.7"	79"	67.7"	79"	90.2"
Non-Angled Length	60.0"	60.0"	62.0"	62.0"	62.0"
Overall Height	28.0"	28.0"	36.0"	36.0"	36.0"
Machine Weight	830 lb.	866 lb.	1,064 lb.	1,104 lb.	1,144 lb.
Direction of Travel	Bi-directional				
Hydraulic Drive Req.	11 gpm @ 2200 psi (min.)		15 gpm @ 2500 psi (min.)		
Drive Chain	#80 Single High Tensile Continuous Roller Chain		#80 Double High Tensile Continuous Roller Chain		
"Aggressor" Rotor	10.125" Overall Dia. with 1.75" Carbide Tipped Teeth				
"Sabretooth" Rotor	10.625" Overall Dia. with 2.0" Alloy Steel Sabre Teeth				
Material Control Bar	Adjustable Height Double Rubber Faced Bar				
Rotor Bearings	1½" Triple Sealed Roller Bearings				
Side Shields	Quick-Flip Design – Flip Up & Lock with Pin				
Angle Control Link	Mechanical Angle – Straight, Left or Right				
Optional Angle Kits	Hydraulic Angle Kit # 6' & 7' – 360779		Hydraulic Angle Kit # 6' & 7' – 360864 8' – 360866		
No. Gauge Wheels	Dual Pneumatic Tires / Spacer Height Adjustment / Gauge Wheels Flip Up & Lock Out of the Way				
Gauge Wheels	16.5 x 6.5 – 8 Pneumatic Tires Tapered Roller Bearing Hubs		18.5 x 8.5 – 8 Pneumatic Tires Tapered Roller Bearing Hubs		
Side Shield Extension	Optional – Kit #360985				

CHECKLISTS

DELIVERY CHECKLIST

Inspect the powered rake thoroughly after assembly to be certain it is set up properly. The following checklist is a reminder of points to inspect. Check off each item as it is found satisfactory or after proper adjustment is made.

- Check operator's manual and familiarize the operator with all sections of it.
- Check that all safety shielding is in place.
- Check all hardware to be sure it is tight or adjusted properly at hinged locations.
- Make sure all hydraulic hardware and hydraulic fittings are tight.
- Check tire ratings to be sure they match the prime mover load. Weigh the powered rake end of the prime mover, if necessary, to insure proper tire rating.
- Check that all lubrication points with grease fittings have been lubricated.
- Check rake attitude, after mounting on prime mover.
- All safety signs (decals) in place and readable.

DAILY CHECKLIST

- Check that the skid steer mounted rake is properly and securely attached to skid steer/prime mover.
- During inspection, check that all nuts and bolts are secure and that all safety shields are in place.
- Check condition of rotor assembly and security of attachment.
- Do not put rake into service unless rotor teeth are intact and in good condition.
- Do not put powered rake into service unless all shields and guards are in place and in good condition. Replace if damaged.
- Check prime mover tire pressure before using.
- Remove from the work area all property that could be damaged by flying debris.
- Be sure all persons not operating the powered rake are clear of the material discharge area.
- Always wear relatively tight and belted clothing to avoid entanglement in moving parts. Wear sturdy, rough-soled work shoes and protective equipment for eyes, hair, hands, hearing, and head.

To the Owner/Operator/Dealer

All implements with moving parts are potentially hazardous. There is no substitute for a cautious, safe-minded operator who recognizes the potential hazards and follows reasonable safety practices. The manufacturer has designed this implement to be used with all its safety equipment properly attached to minimize the chance of accidents.

BEFORE YOU START!!

**Read the safety messages on the implement and shown in your manual.
Observe the rules of safety and common sense!**



THIS SYMBOL MEANS

- ATTENTION!
- BECOME ALERT!
- YOUR SAFETY IS INVOLVED!

THIS SAFETY ALERT SYMBOL IDENTIFIES IMPORTANT SAFETY WARNING MESSAGES. CAREFULLY READ EACH WARNING MESSAGE THAT FOLLOWS. FAILURE TO UNDERSTAND AND OBEY A SAFETY WARNING, OR RECOGNIZE A SAFETY HAZARD, COULD RESULT IN AN INJURY OR DEATH TO YOU OR OTHERS AROUND YOU. THE OPERATOR IS ULTIMATELY RESPONSIBLE FOR THE SAFETY OF HIMSELF, AS WELL AS OTHERS, IN THE OPERATING AREA OF THE TRACTOR AND ATTACHED EQUIPMENT.

UNDERSTAND SIGNAL WORDS



DANGER

Indicates an imminently hazardous situation that, if not avoided, WILL result in DEATH OR VERY SERIOUS INJURY.



WARNING

Indicates a imminently hazardous situation that, if not avoided, COULD result in DEATH OR SERIOUS INJURY.



CAUTION

Indicates a imminently hazardous situation that, if not avoided, MAY result in MINOR INJURY.

IMPORTANT

Identifies special instructions or procedures that, if not strictly observed, could result in damage to, or destruction of the machine, attachments or the environment.

NOTE: *Identifies points of particular interest for more efficient and convenient operation or repair.*

If you have questions not answered in this manual or require additional copies or the manual is damaged, please contact your dealer or the manufacturer directly.

IMPORTANT SAFETY INFORMATION!

Working with equipment can lead to injuries. Read this manual, and the manual for your power unit, before assembly or operating, to acquaint yourself with the machines. It is the implement owner's responsibility, if this machine is used by any person other than yourself, is loaned or rented, to make certain that the operator, prior to operating:

1. Reads and understands the operator's manuals.
2. Is instructed in safe and proper use.



The use of this equipment is subject to certain hazards which cannot be protected against by mechanical means or product design. All operators of this equipment must read and understand this entire manual, paying particular attention to safety and operating instructions, prior to using. If there is something in this manual you do not understand, ask your supervisor, or your dealer, to explain it to you.

SAFETY INSTRUCTIONS (continued)



SAFETY SIGNS

Keep safety signs clean and legible at all times.

Replace safety signs that are missing or have become illegible.

Replaced parts that displayed a safety sign should also display the current sign.

Safety signs are available from your Distributor or Dealer Parts Department or the factory.

How to Install Safety Signs:

Be sure that the installation area is clean and dry. Be sure temperature is above 50°F (10°C).

Decide on the exact position before you remove the backing paper.

Remove the smallest portion of the split backing paper. Align the sign over the specified area and carefully press the small portion with the exposed sticky backing in place.

Slowly peel back the remaining paper and carefully smooth the remaining portion of the sign in place. Small air pockets can be pierced with a pin and smoothed out using the piece of sign backing paper.

***Helpful Hints:** (1) Decals adhere to a warm surface better than a cold surface. (2) Applying heat (from a hair dryer) will greatly improve your ability to remove a damaged decal before preparing the surface for installation of a new one.*





SAFETY TRAINING

 Safety is a primary concern in the design and manufacture of our products. Unfortunately, our efforts to provide safe equipment can be wiped out by a single careless act of an operator. It is the operator's responsibility to read and understand ALL Safety and Operating instructions in the manual and to follow these. Accidents can be avoided.

In addition to the design and configuration of equipment, hazard control and accident prevention are dependent upon the awareness, concern, prudence and proper training of personnel involved in the operation, transport, maintenance and storage of equipment.

 Train all new personnel and review instructions frequently with existing workers. A person who has not read and understood all operating and safety instructions is not qualified to operate the machine. An untrained operator exposes himself and bystanders to possible serious injury or death.

 Know your controls and how to stop skid steer, engine, and attachment quickly in an emergency. Read this manual and the one provided with your skid steer.

 Exposure to respirable crystalline silica dust along with other hazardous dusts may cause serious or fatal respiratory disease. It is recommended to use personal protective equipment during the operation of any attachment that may cause high levels of dust.

SAFETY INSTRUCTIONS (continued)



EQUIPMENT SAFETY GUIDELINES



Safety of the operator is one of the main concerns in designing and developing a new piece of equipment. Designers and manufacturers build in as many safety features as possible. However, every year many accidents occur which could have been avoided by a few seconds of thought and a more careful approach to handling equipment. You, the operator, can avoid many accidents by observing the following precautions in this section. To avoid personal injury, study the following precautions and insist those working with you, or for you, follow them.

In order to provide a better view, certain photographs or illustrations in this manual may show an assembly with a safety shield removed. However, equipment should never be operated in this condition. Keep all shields in place. If shield removal becomes necessary for repairs, replace the shield prior to use.



Replace any CAUTION, WARNING, DANGER or instruction safety sign that is not readable or is missing.



Never use alcoholic beverages or drugs which can hinder alertness or coordination while operating this equipment. Consult your doctor about operating this machine while taking prescription medications.



Always check with your skid steer manual or dealer for counter-weight ballast that may be required for machine stability.



This equipment is dangerous to children and persons unfamiliar with its operation. The operator should be a responsible adult familiar with machinery and trained in this equipment's operations. **Do not allow persons to operate or assemble this unit until they have read this manual and have developed a thorough understanding of the safety precautions and of how it works. Review the safety instructions with all users annually.**



To prevent injury or death, use a prime mover equipped with a Roll-Over Protective System (ROPS). Do not paint over, remove or deface any safety signs or warning signs on your equipment. Observe all safety signs and practice the instruction on them.



Never exceed the limits of a piece of machinery. If its ability to do a job, or to do so safely, is in question – **DON'T TRY IT.**



Do not modify the equipment in any way. Unauthorized modification may impair the function and/or safety and could affect the life of the equipment.













In addition to the design and configuration of this implement, including Safety Signs and Safety Equipment, hazard control and accident prevention are dependent upon the awareness, concern, prudence, and proper training of personnel involved in the operation, transport, maintenance, and storage of the machine. Refer also to Safety Messages and Operation Instructions in each of the appropriate sections of the Power Unit and Powered Rake Manuals. Pay close attention to the Safety Signs affixed to the Power Unit and the Rake.

SAFETY INSTRUCTIONS (continued)



PREPARATION

NOTICE: The Piranha PSS and PSHD Series Powered Rakes are designed for use on standard skid steer power units.

-  Never operate the power unit and rake until you have read and completely understand this manual, the Power Unit Operator's Manual, and each of the Safety Messages found on the safety signs on the prime mover and rake. Only fully trained operators or trainee operators under the close supervision of a fully trained person should use this machine.
-  Personal protection equipment including hard hat, safety glasses, sturdy rough-soled safety shoes, and gloves are recommended during assembly, installation, operation, adjustment, maintaining, repairing, removal, or moving the implement. Do not allow long hair, loose fitting clothing or jewelry to be around moving parts. Always wear relatively tight and belted clothing to avoid entanglement in moving parts.
-  Personal protection equipment including safety glasses, safety shoes, and gloves are recommended during assembly, installation, operation, adjustment, maintaining, repairing, removal, or moving the attachment.
-  Use of a front safety door on the skid steer is recommended for operation of the Powered Landscape Rake.
-  **PROLONGED EXPOSURE TO LOUD NOISE MAY CAUSE PERMANENT HEARING LOSS!**
Power units with or without implements attached can often be noisy enough to cause permanent, partial hearing loss. We recommend that you wear hearing protection on a full-time basis if the noise in the Operator's position exceeds 80db. Noise over 85db on a long-term basis can cause severe hearing loss. Noise over 90db adjacent to the Operator over a long-term basis may cause permanent, total hearing loss. **NOTE:** Hearing loss from loud noise (from engines, chain saws, radios, and other such sources close to the ear) is cumulative over a lifetime without hope of natural recovery.
-  Operate the rake only with a power unit equipped with an approved Roll-Over Protective System (ROPS). Always wear your seat belt on prime mover equipped with a ROPS. Serious injury or even death could result from falling off the prime mover – particularly during a turnover when the operator could be pinned under the ROPS or the prime mover. Keep foldable ROPS systems in “locked up” position at all times.
-  The powered rake's operating power is supplied from the prime mover hydraulic system. Refer to your prime mover manual for hydraulic engagement and disengagement instructions. Know how to stop prime mover and rake quickly in case of an emergency. When engaging hydraulic system, the engine RPM should always be low.
-  Ensure equipment is properly attached, adjusted, and in good operating condition. Skid steer coupler lock-pins must be fully extended and properly engaged into attachment retaining slots.
-  Check prime mover tire pressure before operating. Check tire ratings to be sure they match the prime mover load. Weigh the attachment end of the prime mover, if necessary, to insure proper tire rating.
-  Ensure that all safety shielding and safety signs are properly installed and in good condition.

SAFETY INSTRUCTIONS (continued)



OPERATIONAL SAFETY



Be sure power unit is in good condition. Read all the safety precautions and make sure all operators are familiar with the safety rules of operation. Working with unfamiliar equipment can lead to careless injuries. It is the equipment owner's responsibility, if this machine is used by any person other than yourself, is loaned or rented, to make certain that the operator, prior to operating:

1. Reads and understands the operator's manuals.
2. Is instructed in safe and proper use.

The safe use of this machine is strictly up to you.

All equipment is potentially hazardous. There is no substitute for a cautious, safe-minded operator who recognizes potential hazards and follows reasonable safety practices.



Start power unit only when properly seated in the operator's seat. Starting a power unit in gear can result in injury or death. Do not mount or dismount while the power unit is moving. Mount or dismount the power unit only when the power unit and all moving parts are completely stopped.



Keep all helpers and bystanders fifty feet (50') from an operating power unit and attached equipment. Only properly trained people should operate this machine. It is recommended the prime mover be equipped with a Rollover Protection System (ROPS) and a seat belt that is used. Always stop the power unit, set brake, shut off the engine, remove the ignition key, and lower attachment to the ground before dismounting. Never leave equipment unattended with the engine running.



Never use the skid steer attachment to carry loads that exceed skid steer rated operating capacity or other skid steer specifications. Check your skid steer manual or with your dealer for skid steer rated operating capacity. Exceeding this capacity can cause machine to tip or roll over and cause injury or death.



Do not allow children to operate this machine.



Know your controls and how to stop the power unit and engine quickly in an emergency. READ THIS MANUAL AND THE ONE PROVIDED WITH YOUR POWER UNIT.



Know where the utilities are: Before operating, call your local utilities (CALL 811) for location of buried utility lines, gas, water, sewer, and telephone, as well as any other hazard you may encounter.



Never operate rake toward people, buildings, vehicles or other objects that can be damaged by flying debris.



Only operate the equipment while you are in the operating position. Only operate the controls while engine is running. Protective glasses must be worn while you operate the prime mover and while you operate the rake.





While you operate the rake slowly in an open area, check for proper operation of all controls and all protective devices. Note any needed repairs during operation of the powered rake. Report any needed repairs.

SAFETY INSTRUCTIONS (continued)





OPERATIONAL SAFETY (continued)

-  Always stop the power unit, set brake, shut off the engine, remove the ignition key, lower implement to the ground and allow rotating rotor to come to a complete stop before dismounting. Never leave equipment unattended with the power unit running.

-  Never place hands or feet under rake with power unit engine running or before you are sure all motion has stopped. Stay clear of all moving parts. Keep hands, feet, hair, and clothing away from moving parts.

-  Only engage power when equipment is at ground level. Always disengage power when equipment is raised slightly off the ground.

-  Use of a front safety door on the skid steer is recommended for operation of the Power Rake.

-  Do not allow riders on the rake or power unit at any time. There is no safe place for any riders.

-  Stop skid steer and implement immediately upon striking an obstruction. Dismount skid steer using proper procedure. Inspect and repair any damage before resuming operating.

-  Do not operate unless all personnel, livestock, and pets are fifty feet away to prevent injury by thrown objects. Never direct discharge toward anyone.

-  Air in hydraulic systems can cause erratic operation and allows loads or equipment components to drop unexpectedly. Before operating equipment purge any air in the system by engaging all hydraulic functions.

-  Be especially observant of the operating area and terrain – watch for holes, rocks or other hidden hazards. Always inspect the area prior to operation.

-  Many varied objects, such as wire, cable, rope, or chains, can become entangled in the rotating spiked rotor. These items could then swing outside the housing at great velocities. Such a situation is extremely hazardous. Inspect the area for such objects before operating. Removing any like object from the site. Never allow the rotating spiked rotor to contact such items.

-  Remove from the work area all property that could be damaged by flying debris.







-  Use extreme care and maintain minimum ground speed when transporting on hillside, over rough ground and when operating close to ditches or fences. Be careful when turning sharp corners.

-  Reduce speed on slopes and sharp turns to minimize tipping or loss of control. Be careful when changing directions on slopes. Do not start or stop suddenly on slopes. Avoid operation on steep slopes.

SAFETY INSTRUCTIONS (continued)









OPERATIONAL SAFETY (continued)

-  Before leaving the operator's area for any reason – lower the rake to the ground, stop the power unit engine, set the brakes and remove the key from the ignition.
-  When operating on rough terrain, reduce speed to avoid "bouncing" the rake. Loss of steering can result.
-  When maneuvering close to buildings or passing through narrow areas, be sure to allow sufficient clearance for the power unit and powered rake attachment. Drive slowly.
-  Operate rake from operator's station only. Remain at controls until operating cycle is complete.
-  Keep hands and feet away from rake pivot points and from under rotor.
-  Keep alert and watch the rear as well as the front when working with the powered rake.
-  EXPOSURE TO RESPIRABLE CRYSTALLINE SILICA DUST ALONG WITH OTHER HAZARDOUS DUSTS MAY CAUSE SERIOUS OR FATAL RESPIRATORY DISEASE. It is recommended to use dust suppression, and personal protective equipment during the operation of any attachment that may cause high levels of dust.















TRANSPORT SAFETY

-  Comply with state and local laws governing highway safety and movement of machinery on public roads.
-  Keep powered rake low to the ground when transporting or operating machine. Raising unit off surface could cause roll-over. Also, when transporting in rough terrain, keep gauge wheels on the surface by tilting forward on bucket cylinder and lifting boom slightly.
-  Always operate equipment in a position to provide maximum visibility at all times. Make allowances for increased length and weight of the equipment when making turns, stopping the unit, etc.
-  Watch for obstructions overhead and to the side while transporting.
-  Avoid overhead wires or other obstacles. Contact with overhead lines could cause serious injury or death.
-  Pick the most level route possible when transporting across fields. Avoid the edges of ditches or gullies and steep hillsides. Be extra careful when working on inclines.

SAFETY INSTRUCTIONS (continued)



MAINTENANCE SAFETY

-  Before adjusting or servicing the rake – lower the rake to the ground, stop the prime mover engine, set the brakes and remove the key from the ignition. Repair or adjust the rake in a safe area, away from road traffic and other hazards.
-  Be certain all moving parts on attachments have come to a complete stop before attempting to perform maintenance. Never perform service or maintenance with engine running.
-  Before working on this machine, drive to a level area, disengage the hydraulic power, lower implement (or if working underneath, raise and block securely), shut off the engine, set the brakes, and remove the ignition keys.
-  Remove hydraulic pressure prior to doing any maintenance. Place the rake on the ground or securely blocked up, and turn off the engine. Push and pull the remote cylinder lever in and out several times to relieve hydraulic pressure. Never depend on hydraulic system to keep implement in raised position.
-  When performing service to the drive components or rotor, always relieve hydraulic pressure before uncoupling couplers. Disconnect the hydraulic lines from the power unit and connect the two ends to each other. This will permit the rotor to be turned by hand and prevent the drive parts from accidentally moving while servicing the rake.
-  Keep all persons away from operator control area while performing adjustments, service, or maintenance.
-  Repair loose lines and loose hoses. Repair damaged lines and damaged hoses. Leaks can cause fires. Do not bend high pressure lines. Do not install bent lines or kinked hoses. Do not install damaged lines or damaged hoses.
-  Avoid electrical system hazards. Never work on the electric system unless you are qualified and thoroughly familiar with system details and the special handling requirements.
-  Disconnect battery before working on electrical system. Remove “ground” cable first. When reconnecting battery, connect “ground” cable last.
-  Periodically tighten all bolts, nuts and screws and check that all cotter pins are properly installed to ensure unit is in a safe condition.
-  Never use your hands to locate a hydraulic leak on attachments. Use a small piece of cardboard or wood. Hydraulic fluid escaping under pressure can penetrate the skin. Openings in the skin and minor cuts are susceptible to infection from hydraulic fluid. If injured by escaping hydraulic fluid, see a doctor at once. Gangrene and death can result. Without immediate medical treatment, serious infection and reactions can occur.
-  When completing a maintenance or service function, make sure all safety shields and devices are installed before placing unit in service.

SAFETY INSTRUCTIONS (continued)



MAINTENANCE SAFETY (continued)



After servicing, be sure all tools, parts and service equipment are removed.



Do not disconnect hydraulic lines until all system pressure is relieved.



Check to ensure all safety signs are installed and in good condition. (See safety sign section for location drawing.)



A fire extinguisher and first aid kit should be kept readily accessible while performing maintenance on this equipment.



Never replace hex bolts with less than grade five bolts unless otherwise specified, i.e. shear bolts. Refer to bolt torque chart for head identification marking.

Where replacement parts are necessary for periodic maintenance and servicing, genuine factory replacement parts must be used to restore your equipment to original specifications. The manufacturer will not claim responsibility for use of unapproved parts and/or accessories and other damages as a result of their use.

If equipment has been altered in any way from original design, personal injury could result. The manufacturer does not accept any liability for injury or warranty.



STORAGE SAFETY



Following operation, or when unhooking, stop the power unit, set the brakes, relieve hydraulic pressure, shut off the engine and remove the ignition keys.



Store the unit in an area away from human activity. Do not permit children to play on or around the stored unit.



When disconnecting from the power unit, always relieve hydraulic pressure before uncoupling couplers. Connect the two couplers to each other to help keep them clean and from collecting dirt and foreign material.



Make sure all parked machines are on a hard, level surface and engage all safety devices. Storage location should be level and solid to make connecting and unconnecting to power unit easy.



If blocking is used, make sure it is solid and secure before leaving area.

SAFETY INSTRUCTIONS (continued)

SAFETY PICTORIAL SKID STEER



WARNING!

Important! Be careful when operating the machine. Lifting can be dangerous. Proper machine compatibility is important. Check with power unit owner's manual for proper specifications and ballasting.



CAUTION!

Be sure your prime mover is in good condition. Read all the safety precautions and make sure all prime mover operators are familiar with the safety rules of operation.



Before Starting the Machine: Check all hydraulic hoses for leaks or cuts and either repair or replace. Before operating the machine, be sure you know and understand the controls on both the skid steer and the machine. Inspect the working area for hazards and remove them or make a note of them before you begin. Keep all bystanders at a safe distance while operating equipment.

SAFETY INSTRUCTIONS (continued)

SAFETY PICTORIAL SKID STEER

Special Message: The machine shown in this manual may differ slightly from your machine, but will be similar enough to help you understand our instructions.



WRONG WAY



DANGER!

Never raise the powered rake more than a few feet off the ground. The prime mover can tip over causing death or serious injury.

DO NOT OPERATE Skid Steer with rake off the ground.



CORRECT WAY

When operating or transporting, run the Powered Rake on the gauge wheels. This is done by lifting boom and tilting bucket cylinder forward running gauge wheels on the ground.

SAFETY INSTRUCTIONS (continued)

SAFETY PICTORIAL SKID STEER



WARNING!

Be extra careful when working on inclines. When operating on a slope, always operate up and down the slope, never across the slope.



DANGER!

A heavy load can cause instability in driving a skid steer. Make sure the rear of the skid steer is properly counter-balanced with weights. Always drive slowly – especially around turns. An unstable skid steer could steer badly and possibly tip over, causing injury or death.

Keep loader low to the ground to prevent roll over. NEVER operate with loader up in the air.



CAUTION!

When angling the power rake there could be side pull (rotor walking in the direction the power is directed and rotation of rotor).

Operating the Product: The equipment should be operated with the skid steer engine speed set depending on the application and operator's level of experience. Excessive speeds are dangerous, and may cause damage to equipment and unnecessary strain on skid steer.

SAFETY SIGNS

⚠ WARNING

TO AVOID SERIOUS INJURY OR DEATH:

- Read Operator's Manual before operating, servicing or repairing equipment. Follow all safety rules and instructions. (Manuals are available from your selling dealer.)
- Never allow riders
- Keep bystanders away from equipment during operation.
- Operate from operator's seat only.
- Keep all shields in place and in good condition.
- Lower equipment to ground, stop engine, remove key and set brake before dismounting power unit.
- Never allow children or untrained persons to operate equipment

FAILURE TO FOLLOW THESE INSTRUCTIONS CAN RESULT IN INJURY OR DEATH.

101288

⚠ WARNING



HIGH-PRESSURE FLUID HAZARD

To prevent serious injury or death:

- Relieve pressure on system before repairing or adjusting or disconnecting.
- Wear proper hand and eye protection when searching for leaks. Use wood or cardboard instead of hands.
- Keep all components in good repair.

101122

⚠ WARNING



CRUSHING AND PINCHING HAZARD

- Be extremely careful with various parts of the machine. Pivoting blade can crush or pinch body parts.
- Operate controls from operator's seat only.
- Make sure parking brake is engaged before leaving operator's seat.
- Stand clear of machine while in operation or when it is being raised or lowered.

FAILURE TO FOLLOW THESE INSTRUCTIONS COULD RESULT IN SERIOUS INJURY OR DEATH.

101288



⚠ DANGER

- Stay at least 10 feet (3m) away from operating equipment.
- Flying objects and rotating parts can cause injury or death.
- Stop engine before cleaning or servicing.
- Keep all guards in place.

101311

The model and serial number plate is located on the left side of the main frame.

⚠ CAUTION

- Do not operate power rake without reading the owner's manual and operating instructions completely and being familiar with the operation of the power rake. If operating instructions are missing, contact Worksaver, Inc.
- Keep bystanders away from equipment before operating.
- Never operate rake toward people, buildings, cars, etc.
- Lower equipment, stop engine and rotor, allow all moving parts to stop, remove key and set brake before adjusting or servicing rake.
- Eye protection must be worn at all times by operator and anyone near the power rake.
- Do not operate power rake unless all shields are in place.

101309

BE CAREFUL!

Use a clean, damp cloth to clean safety decals. Avoid spraying to close to decals when using a pressure washer; high-pressure water can enter through very small scratches or under edges of decals causing them to peel or come off.

REMEMBER: If Safety Signs have been damaged, removed, become illegible or parts replaced without Signs, new Safety Signs must be applied. New Safety Signs are available from your authorized distributor or factory.

INSTRUCTIONS

SKID STEER REQUIREMENTS AND PREPARATION

The Piranha PSS and PSHD series Power Rake models are designed for use on standard skid steer power units.

The Power Rakes are offered with a "Universal" style mount, which fits most brands and models manufactured after 1995.

Depending on the size of Piranha Powered Rake, the power unit should have a lift capacity at least of 800 lb. or more and hydraulic system with a continuous minimum flow of 11 GPM @ 2200 psi for PSS models and 15 GPM @2500 psi for PSHD models. Check the specifications of your power unit and check that it can safely handle the size and model power rake you intend to use.

Use of a front safety door on the skid steer is recommended for operation of the Power Landscape Rake.

The operator is responsible for the safe operation of this powered rake. The operator must be properly trained. Operators should be familiar with the rake and skid steer and all safety practices before starting operation. Read the safety rules and safety signs on pages 5-17.

The Piranha Power Rake is designed for removing rock and small debris, tilling soil and for thatching. It will normally require two or three passes over the area to obtain a finished seed bed.

It is recommended to use a power unit equipped with a ROPS (Roll Over Protection Structure) and a seat belt/operator restraint.

Be sure the power units' hydraulic oil and filter have been serviced according to the skid steer manufacturer's recommendations. Check the tires for proper air pressure.

Hoses and flat face couplers from the powered rake unit are included (skid steer applications).



CAUTION!

Be sure your prime mover is in good condition. Read all the safety precautions and make sure all prime mover operators are familiar with the safety rules of operation.



WARNING!

DO NOT MODIFY MACHINE OR ATTACHMENTS

- **Modifications may weaken the integrity of the and may impair the function, safety, life, and performance of the attachment. When making repairs, use only the manufacturer's genuine parts, following authorized instructions. Other parts may be substandard in fit and quality. Never modify any ROPS (Roll Over Protection Structure) or FOPS (Falling Object Protective Structure) equipment or device. Any modifications must be authorized in writing by the manufacturer.**
- **EXPOSURE TO RESPIRABLE CRYSTALLINE SILICA DUST ALONG WITH OTHER HAZARDOUS DUSTS MAY CAUSE SERIOUS OR FATAL RESPIRATORY DISEASE.**
It is recommended to use dust suppression, and personal protective equipment during the operation of any attachment that may cause high levels of dust.

INSTRUCTIONS (continued)

ASSEMBLY / INSTALLATION

This unit is shipped almost completely assembled. The only final assembly required is to mount the caster wheels and arms to the mainframe hinges. Refer to the "exploded view" of your Powered Rake model in this manual. Become familiar with the relationship of the various components and parts shown.

Find a location that is solid and level to do the final assembly and install the rake to your power unit.

Remove the bucket from your skid steer unit. Check the loader arms and cylinders to make sure they are in good working order. Lubricate all loader pivot points. Check all bolts to make sure they are in place and tight.

All reference to left, right, front, or rear are given from the operator's position, facing the direction of forward travel.

It is advisable to have a mechanical lifting device to facilitate uncrating.

UNPACKING CRATE

Be careful of nails in boards when uncrating.

1. Remove top, sides, and ends of crate.
2. Remove rake assembly from crate.
3. Remove loose nails from boards and dispose of crate according to local codes.

INSTALLING FLIP-UP GAUGE WHEELS

Place the pivot end of the gauge wheel arm in the main frame hinge. Using the inside hole, insert the bolt (A) into the hinge hole and thru the hole in the end of the gauge wheel arm. Secure with the nylock nut. Tighten the nut but do not squeeze the side of the hinge assembly. The gauge wheel arm must pivot up and down freely.

Insert the 1/2" x 3" bent hitch pin (PSS models) or the 3/4" x 4 1/4" hitch pin (PSHD models) in either of the other two holes in the hinge plates and through the other hole in the gauge wheel arm. The choice of holes depends on if you want the Flip-Up gauge wheels up or down.

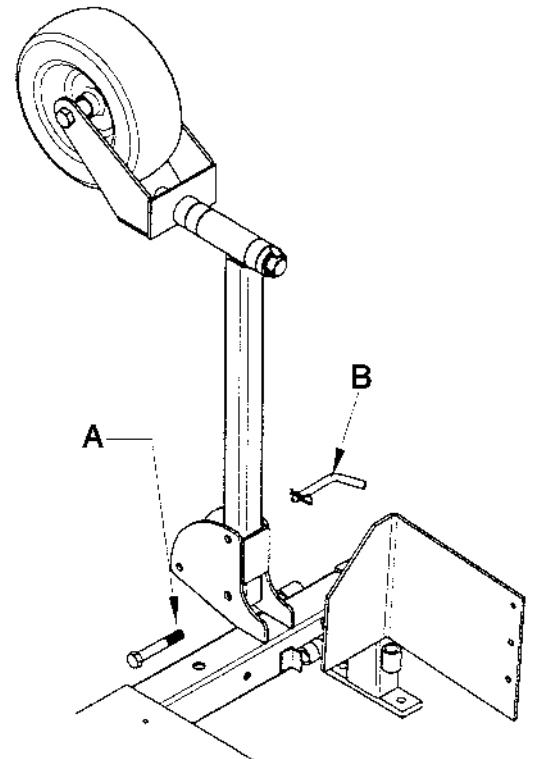

INSTRUCTIONS (continued)

SKID STEER POWERED RAKE INSTALLATION / REMOVAL

TO INSTALL:

1. Read and understand skid steer manufacturer's instructions for installing attachments.
2. The quick attach coupler handles should be in the unlocked position with lock pins retracted, Figure 1.

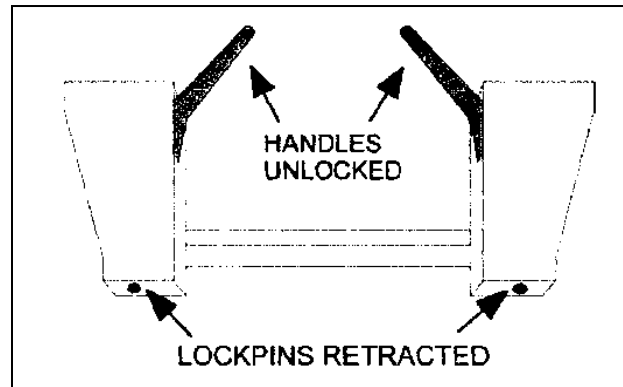

Figure 1. Quick Attach Coupler Handles – Unlocked

3. Enter the prime mover. Fasten seatbelt, start engine. Disengage the parking brake.
4. Follow the attaching procedure in the prime mover owner's manual. Align the attachment mechanism with the mounting on the rake attach to the prime mover or loader.
5. Engage the parking brake and shut down the prime mover. Be sure to relieve pressure to the auxiliary hydraulic lines.
6. Unfasten safety restraints and exit the prime mover.
7. Make sure the hydraulic couplers are clean. Connect the hydraulic lines to the prime mover. Twist the collar of the quick couplers one-quarter turn to secure hydraulic connections.
8. Engage the latching mechanism to secure attachment to loader. The lockpins must be completely extended and secured into the retaining slots provided on, the attachment. Figure 2.
9. Re-enter the prime mover. Fasten seatbelt and restart engine.
10. Carefully raise the loader and cycle the rollback/tilt cylinders to check clearances and to ensure that the attachment is securely mounted.
11. With the skid steer engine at a fast idle, engage the hydraulic lever to allow hydraulic oil to flow to the rake. Allow the rake to operate for a few minutes to work the air out of the lines.
12. If using the electric/hydraulic solenoid valve for angle control, engage the switch and angle the rake several times to work the air out of the cylinders and system.

INSTRUCTIONS (continued)

SKID STEER POWERED RAKE INSTALLATION / REMOVAL (continued)

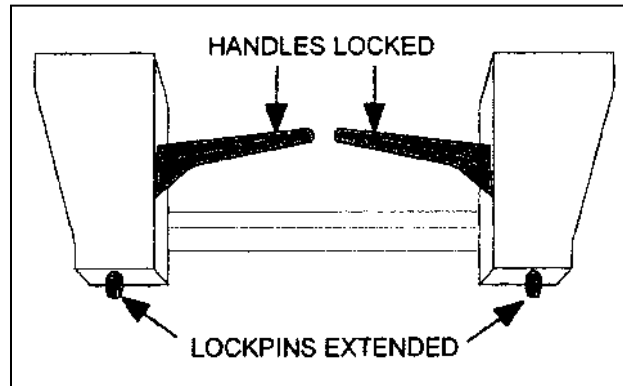

Figure 2. Attachment Coupler Handles – Locked



WARNING!

Attachment coupler handles must always be rotated to LOCK POSITION to prevent coupler latch from disengaging and attachment from falling off.

REMOVING THE RAKE FROM THE SKID STEER

1. If possible, find a level solid location to place the attachment. This makes it easier to disconnect and to re-connect.
2. Lower the attachment to the ground.
3. Engage the parking brake and shut down the prime mover. Be sure to relieve pressure to the hydraulic lines.
4. Exit prime mover.
5. Disconnect the attachment hydraulic lines from the prime mover. Connect quick couplers together to keep clean.
6. Disengage attachment-locking mechanism (mechanical type).
7. Enter and start the prime mover.
8. Disengage attachment-locking mechanism (hydraulic type).
9. Disengage the parking brake, and back away from the attachment.



WARNING!

- Serious injury or death may result from disengaging the attachment when the attachment is in an unstable position. Place the attachment in a stable position before disengaging.
- Hoses for the attachment must be disconnected before the quick attach is disengaged. Pulling the attachment with the hoses could result in damage to the prime mover or the attachment.

INSTRUCTIONS (continued)

ADJUSTING FOR WORK

FLIP-UP GAUGE WHEELS

Placing the gauge wheels in the up position will put the Piranha Power Rake in the tilling mode. The tilling mode is best for the first pass on a job site and for working hard packed soil areas.

When the gauge wheels are down and the spacers properly located, the wheels will control the depth of operation and the leveling of the soil.

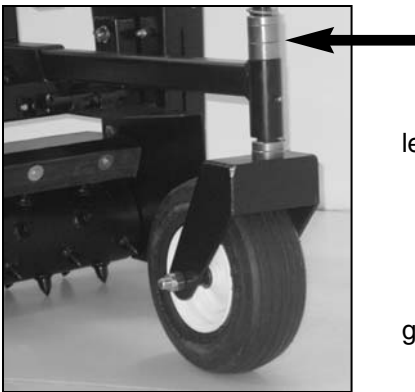

Posi-Lock wheel spacers allow the adjustment of the gauge wheels for proper leveling of the machine, which determines the rotor cutting depth.

To allow the rotor to penetrate deeper into the ground, raise the gauge wheels.

Be sure to check the air pressure in each tire regularly so that an even, consistent grade will be maintained.

Flip-up gauge wheels also allow for easier storage and trailer transport (takes up less room on the trailer).

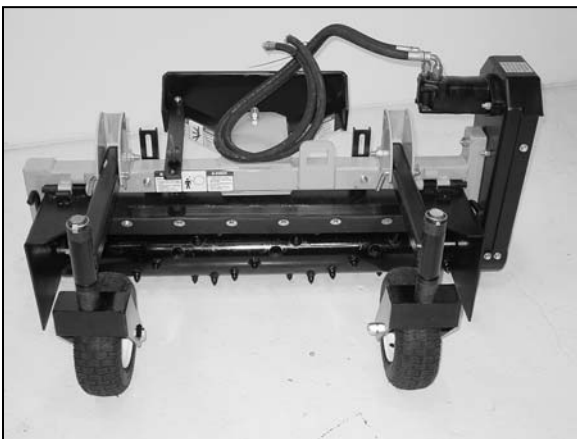

**Model
PXS-410
Shown**

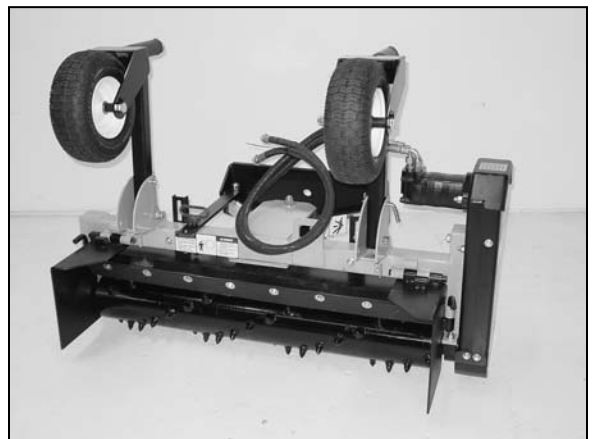

To flip-up the gauge wheels, take some pressure off the wheels by lifting the unit up slightly. Remove the pin and raise the wheel assembly to the upright position. Install the pin in the upper hinge plate hole and thru the gauge wheel arm to lock it in place. Replace the clip in the end of the pin.

NOTE: The machine can be operated with one gauge wheel up and one down if you wish to slope the area.

NOTE: If rocks or debris accumulate between the rotor and the gauge wheels, then the wheels should be placed in the upright position to prevent wheel damage.

INSTRUCTIONS (continued)

ADJUSTING FOR WORK

MATERIAL BAR

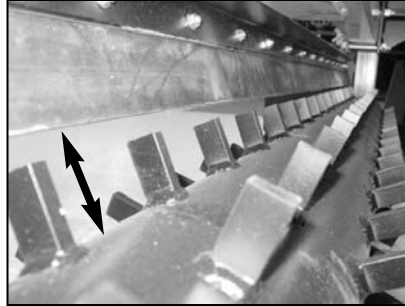

The material control bar is located just above the rotor and determines how much material is going through the machine. This bar is adjustable by loosening the bolts, adjusting the bar up or down and tightening the bolts. The greater the distance between the rotor and the bar, the more material will pass over the rotor. The bar can be set down far enough to hit the teeth – you'll hear a helicopter sound when set in this position. Operating the machine in this position may cause premature wear, but will sort out smaller debris and rocks.



How it works!

Shows material being processed into the Piranha. The rotor is loosening the rocks and dirt, pulling the material to the surface. The material bar is holding back the rock while letting the processed "dirt" flow through the machine.



Material Bar Adjustment

Adjustable up or down for processing material over rotor and through machine. To adjust the materials bar loosen nut on back side of frame and adjust either up or down. Adjusting up will let more material processing through machine adjusting down will hold back material like rocks and debris. When adjusting the materials bar, check both sides for levelness. Adjusting one side may have an effect on the other side.

The normal gap between the rotor and material bar for average conditions is about 1¼". This gap can be adjusted either wider or narrower by loosening the bolts (2) (PSS Models) or removing the bent hitch pins (2) (PSHD Models) that hold the material bar and sliding it up or down. A wider opening will allow more dirt and rock to pass through. For finer raking, reduce the gap. Be careful not to let rotor hit the rubber strips as premature wear will occur. (See top paragraph on this page.) The gap should be the same all the way across. Material bar adjustment is shown in the photo above.

INSTRUCTIONS (continued)

ADJUSTING FOR WORK

SIDE SHIELDS

The function of the side shields is to contain the material in front of the rotor while the clean material passes between the rotor and material control bar.

With the side shields in the working (down) position and the rotor straight (parallel with prime mover), material can be moved along, filling in the low spots.



Side Shield in down or working position.



Side Shield shown with optional Side Shield Extension in down position.



Side Shields

There are two positions, either up or down. To quick flip the side shield up, remove the pin, flip shield up, and place the pin in the horizontal tubes on the frame and the top of the shield. The purpose of the side shields is to carry rocks and debris along, sifting out the dirt as you go. At the end of the row, lift the rotor to deposit the rocks and debris in a pile.

IMPORTANT!

When operating in unprocessed ground/job site either remove or flip up side shields. Hitting unexpected rocks, tree roots etc. may damage side shields. Side shields are used on the final pass to collect surface rocks and debris. Side shields are NOT intended for land clearing!



OPERATING INSTRUCTIONS

GENERAL SAFETY

Only qualified people familiar with this manual should operate this machine. Operator should wear hard hat, safety glasses, and safety shoes. Prime mover must be equipped with a Roll-Over Protective System (ROPS) and a seat belt that is used. Before beginning operation, clear work area of objects that may be picked up, thrown, or entangled. Check for ditches, holes, or other obstacles that could upset prime mover or damage the powered rake. Always turn off prime mover engine, set parking brake, lower rake to ground and allow machine to come to a complete stop before dismounting prime mover.

The designed and tested safety of this machine depends on it being operated within the limitations as explained in this manual. Be familiar with and follow all safety rules in the manual, on the powered rake and on the prime mover.

The safe operation of this machine is the responsibility of the owner/operator. The operator should be familiar with the powered rake and prime mover and all safety practices before starting operation. Read the safety rules on pages 5 thru 16.

PRE-OPERATION CHECKLIST

(OWNER/OPERATOR RESPONSIBILITY)

- _____ Review and follow safety rules and safety signs on pages 5 through 17.
- _____ Check that the powered rake is properly and securely attached to skid steer and that all hardware is properly installed.
- _____ Lubricate all grease fitting locations.
- _____ Check that all shields and guards are properly installed and in good condition.
- _____ Check rotor height, front to rear attitude and side to side rotor height.
- _____ Place prime mover transmission in neutral before starting engine.
- _____ Inspect area to be worked and remove wire, twine, branches or other objects that might be wrapped or thrown, causing injury or damage.
- _____ Check that no one enters the area of machine operation. Always work at a safe distance from people.
- _____ Know your controls and how to stop prime mover, engine and powered rake quickly in an emergency. **READ THIS MANUAL AND THE ONE PROVIDED WITH YOUR PRIME MOVER.**
- _____ Always wear proper apparel such as a long sleeved shirt buttoned at the cuffs; safety glasses, goggles or a face shield; ear protection; and a dust mask.



WARNING!

- **Never raise the powered rake more than a foot (12") off the ground. The prime mover can tip over causing serious injury.**
- **Do not become entangled in the hydraulic hoses. Tripping while entering or exiting the skid steer operator station can cause serious injury.**

OPERATING INSTRUCTIONS (continued)

OPERATION

FUNCTION OF THE POWER RAKE

The hydraulic motor drives the toothed rotor, which digs into the ground, tilling the soil and pulling up rocks, roots and debris.

The loose clean soil goes over the rotor between the rotor and material control bar, while the rocks, roots and debris either accumulate in front of the rotor (straight position) or work to the side in a windrow (angled position).

With the side shields in the working (down) position and the rake straight, material can be moved along, filling in low spots. Roots, rocks and debris can be collected and located where it can be hauled away.

POWERED RAKE ROTOR

The rotor is equipped with either carbide tipped teeth or alloy steel sabreteeth. Each have advantages depending on operating conditions and personal preference.

The Rotor should be level with the ground. The power rake should also be level with the ground front to back. To accomplish this, raise or lower gauge wheels and/or use the prime mover tilt cylinder.

To allow rotor teeth to penetrate deeper into the ground, adjust the spacers and raise the gauge wheels. To achieve the opposite, lower the gauge wheels.

The chain case end of roller weighs approximately 80 lbs. more than the other end of rotor. To compensate for this, you should set the gauge wheel closest to the chain case down ½"-1" (depending on soil conditions) lower than opposite wheel. This will still give an even grade when landscaping. This is important during the final finish pass – it is not critical when making the first trip over the area.

During operation, further depth control can be achieved by tilting the rake forward on gauge wheels to raise rotor, or by tilting the rake back to raise gauge wheels and allow more rotor penetration.

Be sure to check the air pressure in each gauge wheel tire regularly so that an even, consistent grade will be maintained.

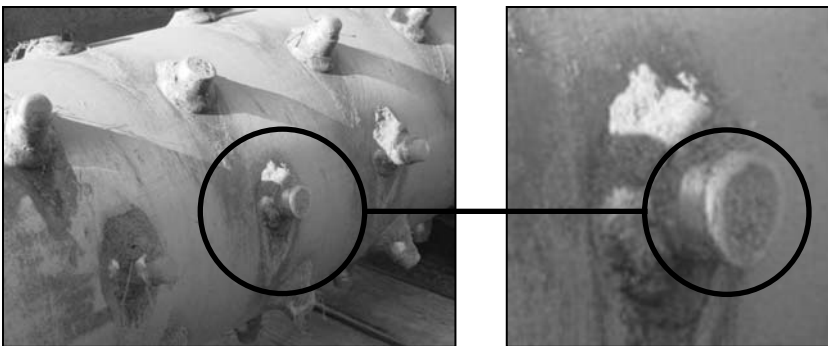

Carbide Tooth

Carbide being an extremely hard material will break, snap or shear out of holder. This is a fact of ground engaging equipment and can be expected. Also, as wear occurs the shank or holder may be worn down because of abrasion of the tooth shank and the carbide insert will fall out.

The rotor on the hydraulic power rake is **bi-rotational**. You can operate the rotor in both directions clockwise and counter-clockwise. The rotor operates most efficiently when it rotates in the opposite direction of the prime mover wheels.

NOTICE: When operating and engaging the rotor to ground contact, engage the hydraulic drive and slowly make ground contact. **DO NOT SLAM INTO THE GROUND.** Damage may occur to machine and/or power unit.

OPERATING INSTRUCTIONS (continued)

OPERATION

POWERED RAKE ROTOR (continued)



WARNING!

Rotor Wrapping

Material such as rope, wire, roots, plastic etc. may wrap around rotor. **STOP IMMEDIATELY** and remove foreign material. Spinning of rotor and throwing of material may cause harm to operator/bystander!

Rotor wrapping may cause damage to bearing and bearing seals by jamming/cutting causing premature wear and damage.

Sometimes, you can remove wrapped roots/grass by stopping the forward motion of the skid steer and raising the rotor about 8" - 10" above the ground. Then at a slow speed reverse the rotating direction of the rotor. Wrapped roots and grass will usually unwrap from the rotor and fall to the ground. Do NOT try this with wrapped wire, rope or other material.

Material such as rope, wire, or plastic will usually not unwrap this easily. For more serious wrapping problems, follow instructions below:

Removing Wire, Twine, Weeds, etc. that are Wrapped Around the Rotor

1. Place your prime mover on a level surface with this product properly attached.
2. Place your prime mover's transmission in "Park" and engage the parking brake.
3. Lower this product onto preplaced blocking that will support the frame so that the rotor teeth are not in contact with the ground.

WARNING!



Do not use blocking made of concreted blocks, logs, buckets, barrels or any other material that could suddenly collapse or shift positions. Do not use wood or steel blocking that is warped, twisted, or tapered. Failure to obey this warning could result in death or serious injury.

4. Shut off your prime mover's engine, remove the starter key, wait for all moving parts to come to a stop, and relieve all pressure in the hydraulic lines.
5. Disconnect the hydraulic lines from your prime mover and connect the two ends to each other. This should permit the rotor to rotate freely.
6. Pull the material from the roller while allowing it to rotate manually.

Protective Collars

The rotor bearings have special protective collars to protect the bearings from root, vine, and wire wrap, and dirt next to the bearing seal. These bearing protectors mounted on the rotor shaft and rotate with a close clearance to the outer bearing race.

The bearing protector on the drive end of the rotor is welded to the rotor drive hub.

Bearing protectors will increase the life of the bearings and seals.

OPERATING INSTRUCTIONS (continued)



OPERATION

POWERED RAKE ROTOR (continued)

The normal gap between the rotor and material control bar for average conditions is about 1¼". This gap can be adjusted either wider or narrower by loosening the bolts (2) that holds the material bar and sliding it up or down. A wider opening will allow more dirt and rock to pass through. For finer raking, reduce the gap. Be careful not to let rotor hit the material bar rubber strips. Having the rubber strip hit the rotor teeth will reduce the amount and size of material going over the rotor, but it will cause increased wear on the rubber strips. The gap distance should be the same all the way across. Material bar adjustment is shown on page 23.

The rotor on the hydraulic power rake is **bi-rotational**. You can operate the rotor in both directions clockwise and counter-clockwise. The rotor operates most efficiently when it rotates in the opposite direction of the prime mover wheels.

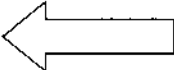
For the rotor to operate effectively, it should rotate in the opposite direction of the prime mover wheels.

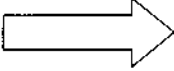
Rotor Rotation	Travel Direction
	
	

NOTICE: Material like rocks and debris can be lodged between rotor and material bar. If you continued to run the machine with jamming/stalling conditions you will damage the machine. Damage of the material bar, bending the material bar, ripping or cutting the rubber strip could occur.

NOTICE: Being a ground engaging piece of equipment, tooth breakage and damage can be expected. Up to 10% tooth breakage or damage should not affect machine performance. (As long as it is not all in one location or end.)



DANGER!

- The powered rake may pick up a post, length of wood, stake, etc. this long length of material may come out rapidly as a projectile and could cause injury or death. Always check work area before operating machine and remove any items that could become a dangerous projectile.
- Material such as rope, wire, roots, plastic etc. may wrap around rotor. The rotor may throw material that may cause harm to operator/bystander.
Always remove any material that could wrap on the rotor and be thrown.
- Rocks can be chipped or thrown by the rotor and cause serious injury or property damage. Wear safety glasses at all times and keep bystanders away.

Operating Depth

When power raking, the depth will determine how much dirt is carried ahead of the rotor. The ideal depth will vary with conditions and can be anywhere from skimming the surface to about 3" deep. See instructions on page 26 to set rotor depth.

When making the first windrow (angling only), the level of dirt may be halfway up on the material bar. When moving the windrow two or three times, the level of the dirt may be to the top of the material bar. However, try to prevent material from flowing over the top.

The power rake allows fast raking of large areas of ground by being able to move windrows several times. Of course, the volume or density of the material being raked will dictate how many times a windrow can be moved. When the volume of material in the windrow becomes more than the rake handles easily, you need to remove the undesired material with a loader bucket.

OPERATING INSTRUCTIONS (continued)

OPERATION

Hydraulic Drive Motor

The hydraulic drive motor runs off the auxiliary circuit of the auxiliary hydraulic circuit of the prime mover. The power rake should be run at approximately 25%-30% power for one hour for proper motor break-in.

For hydraulic drive, normal operating rpm of the rotor is approximately 210. If operating in heavy rock, reduce speed as appropriate.

When starting operation, have the engine rpm at approximately one-quarter throttle and that the rotor slightly above the ground before engaging the auxiliary hydraulics. Then carefully and slowly lower the rotor and then smoothly increase throttle speed until you reach full operating speed. NEVER engage the auxiliary hydraulics at full engine rpm. Damage to the driveline or rake could occur.

Ground Speed

Ground speed should be between 3 and 5 mph under normal conditions. In heavy rock, reduce the ground speed to 1 to 3 mph.

Generally, a slower forward speed results in a finer finish, while a higher speed results in a coarser finish. Excessive ground speed may result in dirt or material passing over the top of the material control bar or too much material being windrowed off to the side. Powered Rakes do not perform well in wet sticky soil or making sharp turns when in contact with the ground.



NOTICE: When angling the power rake, there could be side pull (rotor walking in the direction the power is directed and rotation of rotor). Operator must be aware of this and steer the prime mover to stay in the intended direction.

Side Shields

The function of the side shields is to contain the material in front of the rotor while the clean material passes between the rotor and material bar.

With the side shields mounted in the working position and the rotor straight operating position (parallel with prime mover), material can be moved along, filling in the low spots.

Make sure the disconnected power rake is stored on a hard, level surface. Placing the side shields on the attachment side of rake will increase stability.

Optional side shield extensions may be bolted to the side shields. This will strengthen the lower part of the side shield (rocky conditions) and allow the shields to operate lower and further forward (if desired). Order kit # 360985.

5 Hour Break-In Period

After running the machine for 5 hours, check for loosening of bolts. Relocking and tightening bolts prevents bolts from loosening up again. DO NOT over tighten bolts – over tightening bolts can cause stretching of the hardware, causing stripping of hardware. After break-in period, machine needs to be regreased.

OPERATING INSTRUCTIONS (continued)

OPERATION

Successful operation of the power rake will come with operator experience. The rake's performance also depends on the type and size of the prime mover it's mounted on.

An operator that masters the technique of adjusting the angle of attack of the rotor against the soil will also find ideal settings under various conditions to give the desired results.

NOTICE: Do not drop power rake to the ground with the rotor turning. Sudden high speed jolts multiply stress to the driveline and can cause extreme damage.

FLEX AND FLOAT

The skid steer mounting plate on both the PSS and PSHD models is connected to the "A" frame with removable pins in the lower holes. The pins can be removed and stored in the back upper holes of the mount.

Tilt the skid steer mount plate slightly forward (20-30°) when operating in the Flex/Float position. This will allow the powered rake to follow the contour of the ground freely.

Placing the pins in the lower mount holes locks the skid steer mount to the "A" frame. This allows the operator to apply down pressure to the rotor and obtain a more aggressive action. **NOTE:** The hydraulic motor may stall out if too much down pressure is applied.

NOTE: It is recommended to install the pins in the locked position when transporting the powered rake.

APPLICATION PROCEDURE

The power rake is capable of many applications. The following are some of the common applications:

Preparing the Surface

When landscaping in an area with a lot of tall grass, clear cut the area first either by mowing or tilling the ground. Tall grass may have a tendency to get caught and wrap in the rotor. If mowing, let grass dry for a couple of days or mow a second time 90° from first mowing.

Pulverizing Topsoil

For breaking up compacted soil or conditioning hardened baseball diamonds, the attachment plate is rolled back to take the guide wheels off the ground so only the toothed rotor is in contact with the ground. Maintain sufficient RPM to avoid stalling the toothed rotor in its progress. The rake can be straight or angled, but the side shields should be locked up in order to allow material to move out of the way and not slow the process.

Debris Removal



Once the surface has been loosened, the process of removing debris can begin. The prime mover attachment plate is tilted forward until the guide wheels control the depth of the toothed rotor. The rotor can be angled at this time for windrowing debris or the rotor can be set straight with both side shields down to collect debris. Prime mover travel speed can be increased for this process.

Work Site Preparation: The Piranha Power Rake works excellently getting the work site cleaned up and free of rocks and debris. You may either collect or windrow the material off the work area.

OPERATING INSTRUCTIONS (continued)

OPERATION

OPTIONAL HYDRAULIC ANGLE ADJUSTMENT KIT

If the optional hydraulic angle kit is field installed, the valve mounting bracket needs to be bolted to the frame. On the PSS Models, the bracket bolts to the top pivot plate in the center of the frame. The valve needs to be mounted toward the skid steer. For the PSHD Models, the valve mounting bracket bolts to the welded lift bracket. The valve assembly must be located toward the skid steer.

Refer to pages 56, 57 and 58 for information on the hose and fitting connections.

NOTE: The two hoses # 2505781 (5/8" X 84") that originally went from the skid steer to the motor, are now used from the skid steer to the valve.

Direction Control Switch (Hydraulic Angling Model Only)

A three position switch is provided to angle the rake left or right. The switch is equipped with a magnetic mount and may be attached to a convenient steel surface near the operator. The direction valve uses a small amount of hydraulic oil bypassed from the roller drive motor and will only operator with the prime mover auxiliary hydraulic system engaged and with the roller turning clockwise (viewed from the left or chain case end).

Connect the power cord to the cable coming from the switch. Be careful when routing the cable that sharp edges or moving parts will not damage the cable. Use plastic ties to fasten the wiring cable in a safe location so it will not be pinched or damaged.

Connect the wiring harness to the two solenoid coils on the valve using the Deutsch type connectors. Make sure they are fully engage. Then connect to the skid steer battery – connect the (red) power clamp first and the (black) ground clamp last.

When connecting for the first time, raise the rake slightly and cycle fully to the left and then right several times to work air out of the system.

With the prime mover auxiliary hydraulic system engage, move the spring loaded switch in one direction and the rake will angle left or right. Return the switch to center position and rake will maintain the angle selected. Pivot rake to place the windrow left or right of the skid-steer.



CAUTION!

- **Avoid electrical system hazards. Never work on the electrical system unless you are qualified and thoroughly familiar with system details and the special handling requirements.**
- **Disconnect battery before working on electrical system. Remove “ground” cable first. When reconnecting battery, connect “ground” cable last.**

OPERATING INSTRUCTIONS (continued)

OPERATING TIPS (continued)

Spreading Fill and Topsoil

Position rake so it is tilted on gauge wheels, since depth of cut is not the objective. Side Shields can be down and the windrow angle set as needed to control the material movement.



After work site has been prepped in and you find you need to bring in more dirt or sifted dirt the Piranha Power Rake may be used to process and lay down the material. By using the power rake it will break up clumps and remove any unwanted debris.

Changing Grade

Grade modification can be accomplished during finish grading by angling the rake to collect and windrow the maximum amount of material toward targeted areas.

By decreasing the gap between the rotor and material control bar, more material can be pulled along.



Setting Grade, Job Site Leveling: Getting the job site ready is an important step. This is where you set grade, loosen up the material, start obtaining a 2 in. seed bed.

Blending Adjoining Areas

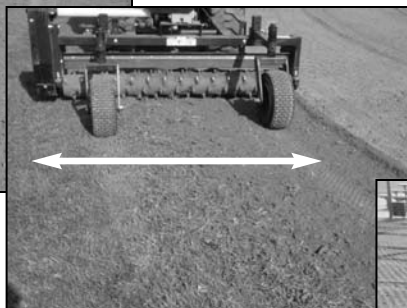
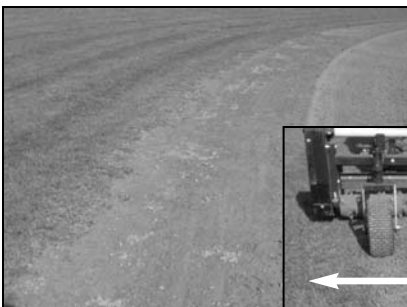

Blending existing and processed lawn together: Set gauge wheels on one side of the machine, let 6" up to 12" of rotor over hang the existing lawn. Out side rotor tooth will be either just touching or not touching surface, while other side will be touching and processing the material to bring the two surfaces together.



Dimpling: If water pockets are needed for water control. This may be achieved by processing the soil and then setting the teeth just off the surface and let the teeth dimple the work site.

OPERATING INSTRUCTIONS (continued)

OPERATION

Finish Grading

The rake is tilted forward until the teeth of the toothed rotor are barely touching the soil. Prime mover speed can be increased for this operation, the idea being to collect material from the high spots and leave it in the low areas.

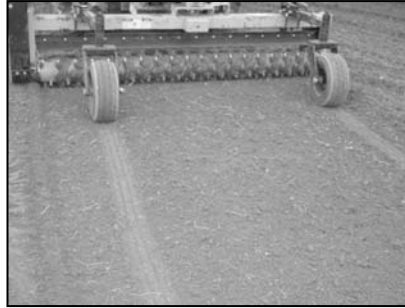

Final Grade: Set the rotor teeth so they are just touching the surface. This will collect the small rock and debris. This is where the raking action occurs not the processing action. (see note)

NOTICE: Raking action is the setting where only the teeth are just touching the ground. In this setting, the operator needs to concentrate on driving straight, blending each and every raking pass together. In the raking mode, you should have NO material going over the rotor.

Thatching Existing Grass Areas

The prime mover attachment plate should be tilted forward to support the rake on the front gauge wheels and toothed roller raised so teeth are just grazing the surface. Travel speed should be slow and careful.

The right finish is achieved through a combination of proper soil moisture conditions, operating depth, ground speed, material control bar opening and rotor angle. As you gain experience, your Powered Raking capabilities will improve.

OPERATING TIPS

1. Walk around the work site, check for underground obstacles like electrical and utilities, property line stakes, large rocks, buried concrete or ledge rock. Plan on where to deposit unwanted debris and material.
2. If you are inexperienced with operating a Power Rake, find an area that is dry and allows you to make at least a 50 ft. run.
3. Begin traveling forward while gently lowering the running Power Rake to the ground. Make slight changes and observe the result.
4. The Powered Rake should be set to operate level. Make adjustments with the power unit or gauge wheels to achieve this.
5. Hard Packed Soil – After the first pass, you may notice hard spots in the work area. Put the Piranha Power Rake in a tilling mode by raising the side shields and the gauge wheels. Then make several passes over the hard trouble spots. Tracks and ruts made by construction equipment need to be taken care of to achieve a proper seedbed.
6. If the work area has considerable tall grass or green material you may need to raise the material control bar so material can flow through. You may also be required to mow or use a rototiller before using the Powered Rake. If you mow, the area will process better if you let the green material dry out first.

OPERATING INSTRUCTIONS (continued)

OPERATING TIPS (continued)

7. When the work area is tilled up, put the Powered Rake into landscape mode (side shields down and material control bar lowered) with gauge wheels set to control operating depth. This will allow removal of smaller size rock and debris.
8. For the final pass, set the Powered Rake so the rotor teeth are just touching the surface. Have the side shields lowered and check the machine so it is level. (Side shields not level can allow material to escape under them leaving a small windrow of unwanted material.)
9. Keep an eye on the rotor. Check for any foreign objects that may be wrapped around the rotor or lodged between the studs. Do not let material wrap between the rotor ends and the bearings. This will damage the bearing seals and ruin the bearings. Remove any wrapped material promptly.
10. It will take 2 or 3 landscape jobs to understand all the benefits of using a Powered Rake. If one adjustment is not correct, it may not work up to your expectations.

OTHER TIPS

Where to use a tiller

When breaking new ground or loosing up hard spots in the job site, scrub and flower gardens, small gardens, in new home/commercial property loosing up the job site tracks. The tracks compacted by concrete and job site trucks going to and leaving the job site. These tracks are very hard and getting grass to grow is almost impossible without loosing up the sub surface material.

Sometimes gauge wheels in the landscaping mode just don't work

There are times gauge wheels just don't work. Example's: ditch line and banks, getting into and back grading the bottom of ditches with the gauge wheels down usually doesn't work. The gauge wheels will pick the rotor off the ground leaving material and filling in the ditch. Solution: flip-up the gauge wheels and operate the Piranha manually.

BALL FIELD TIPS

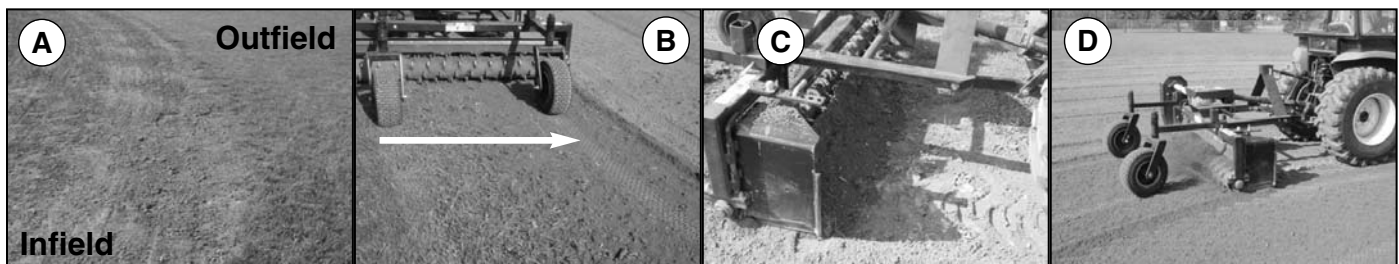

The Piranha Power Rake works great on maintaining ball fields. Blending the infield and outfield can eliminate any dangerous ledges. Maintaining a level grade can also prevent water-holding areas.

Figure A shows the infield and outfield. To process and blend the two surfaces together, set the Power Rake so the outfield side is higher than the infield side. Figure B shows a machine blending in an infield and outfield. Figure C shows a Power Rake working the dirt area of the infield. The side shields are down and level so the rake can carry material along and deposit it in any low spots. Some ridging may occur, but this is OK as the main purpose is to loosen and level out the dirt. Figure D shows the final step of raking and leveling. The rotor and machine must be level. This will remove any ridges and leave a finished ball field.

OPERATING INSTRUCTIONS (continued)

OPERATING TIPS (continued)

SKID STEER OPERATION

Forward operation makes it easy to see where you're going and job site conditions. Forward operation is preferred when roughing in job site, collecting rocks and debris, tilling operation, or setting grade. The problem is going forward – you leave wheel tracks with the power unit.

Backwards operation removes wheel tracks - this is commonly preferred during the final step.

IMPORTANT – Avoid Power Rake damage. DO NOT ram into piles of debris. Use a blade or loader bucket for this type of job.

LARGE AREAS

When raking a large area, make a path down the middle and rake to both sides. This reduces the amount of debris the rake must move to one side.

HEAVY DEBRIS

Travel slowly – 1 to 2 mph. Rake a path less than the full width of the Power Rake. Decrease forward speed if debris becomes very heavy.

GENERAL DRIVEWAY AND ROAD MAINTENANCE

Gravel processing and road maintenance may be done with a Piranha Power Rake. Potholes can be a real problem. Just filling them in usually does not work. The rim of the pothole needs to be cut out. The Power Rake rotor can cut and grind the material leaving a level surface.

A common problem with gravel driveways/roads is that the rock type gravel becomes packed down leaving the fines or sand. The usual repair is to bring in more gravel. By processing the existing gravel, the Power Rake will bring the rock part of the gravel back to the surface and many times there is no need to bring in more gravel.

If more gravel is needed, the Power Rake can spread it evenly. Set the material bar so more material will flow over the rotor. Adjust the material bar for the amount you want to put down.

MATERIAL BAR: Set the material bar to regulate the amount of material needed to flow through the Power Rake.

GAUGE WHEELS: Most driveways/roads need a pitch for proper drainage. This may be accomplished by changing the spacers on the gauge wheel spindles. (Make one side higher or lower than the other).

SIDE SHIELDS: Having the side shields down will collect and hold material and help carry it to fill in low spots. Removing or flipping-up the ditch side end shield will let the rotor teeth have more contact with the base surface.

NOTE: Removing or flipping-up the side shields will prevent them from being damaged if you make contact with ledge rock, roots or other sub-surface objects

OPERATING INSTRUCTIONS (continued)

TRANSPORTING

WHEN TRAVELLING TO ANOTHER WORK AREA:

Keep the Powered Rake low to the ground when transporting or operating the machine. Raising the rake over 2 ft. off the surface could cause a roll over. When transporting, keep the gauge wheels on the surface by tilting forward with the tilt cylinders and lifting the loader boom slightly.

Pick the most level route possible when transporting across fields. Avoid edges of ditches or gullies and steep hill-sides.

Allow for additional length and width of prime mover and attachment when turning.

TRANSPORTING UNIT ON TRUCK OR TRAILER:

The unit may be lifted and moved by a crane.

Disconnect power rake from skid steer unit.

Secure crane hook to lift lug located on top of main frame.

Lift the entire unit off the ground and carefully load on truck or trailer. Use extra care when loading or unloading unit onto trailer or truck.

Tie unit down with straps or chains over the main frame and mounting plate. Be careful not to damage hydraulic hoses, motor or angle linkages when securing unit.

Gauge wheels may be fastened in the "up" position to take less room on the trailer.

POWER RAKE STORAGE

Clean all debris from the machine and power wash. Grease all grease fittings.

Remove drive chain, clean and then soak chain in oil for 24 hours, reinstall on machine.

Make sure there is no water in the chain case when machine is put into storage. In cold/freezing climates, water can freeze and damage chain case.

Disconnect hydraulic hoses from prime mover. Install dust plugs or couple hoses together, as appropriate. Disconnect angle direction control switch from prime mover power and remove switch.

Disengage your Power Rake from the prime mover. Be sure your Power Rake rests in a stable position for storage.

Be sure your power rake is stored on a hard, level surface.

Block equipment securely for storage.

Keep children and bystanders away from storage area.

Check over the machine for worn or damage parts/components. Order replacement parts.

OWNER SERVICE

The information in this section is written for operators who possess basic mechanical skills. Should you need help, your dealer has trained service technicians available. For your protection, read and follow all safety information in this manual.

Regular preventive maintenance and immediate repair of broken or worn parts will ensure maximum efficiency and long life.

WARNING!



NEVER GO UNDERNEATH EQUIPMENT. Never place any part of the body underneath equipment or between moveable parts even when the engine has been turned off. Hydraulic system leak down, hydraulic system failures, mechanical failures, or movement of control levers can cause equipment to drop or rotate unexpectedly and cause severe injury or death.

Read Manual for service instructions or have service performed by a qualified dealer.

WARNING!



Keep all persons away from operator control area while performing adjustments, service, or maintenance.

Before dismounting power unit or performing any service or maintenance, follow these steps: disengage power to equipment, lower all raised components to the ground, operate valve levers to release any hydraulic pressure, set parking brake, stop engine, remove key, and unfasten seat belt. Never leave equipment unattended with engine running.

POWER RAKE LUBRICATION

GREASE REQUIREMENTS: Use any high-quality, multi-purpose #2 or lithium grease

Clean off grease fitting before greasing. NOT cleaning off grease fitting will insert/inject foreign material into system creating damage and undue wear. If grease comes out of grease fitting it means the grease fitting is damaged. Either remove grease fitting and clean out old dried up grease or replace grease fitting. Grease the machine when not using it for extended time or when putting it in storage for the season. Grease the machine when washing or storing it out side in the weather, this will blow out any water that may get into system and creating a seal to keep dirt from entering.

Never lubricate or service machine while its is running.

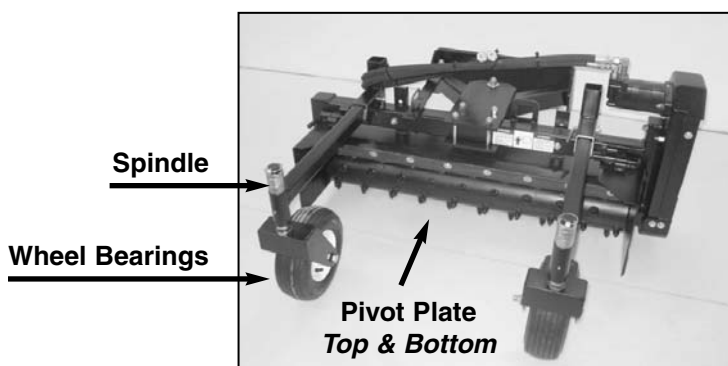

NOTICE: Pivot greasing is VERY important. If not properly greased and maintained, manual angle will be very hard if not impossible to turn. Make sure to grease both top and bottom grease fittings. After greasing pivot frame, swing unit left and right several times to smear grease on pivot plate.

Check rotor bearing and drive chain lubrication instructions on the following pages.

ANNUALLY

Repack the bearings in the wheels as described in steps below.

Make sure that there is no weight on the wheels. If the wheels are partially supporting the weight of this product, restart your prime mover and move the loader and/or dump cylinders. Repeat the specified shutdown procedure.

Remove each wheel using wrenches and remove the bearing components from the wheels. Clean the bearing components, and then use a high quality waterproof grease to repack the bearing components and hub.

Reassemble all components using new seals.

OWNER SERVICE (continued)

ROTOR BEARINGS

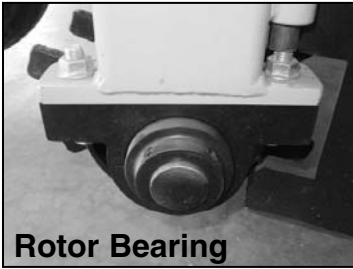

Rotor Bearings

The rotor has triple seal bearings on the left and right side that come plugged from the factory. Grease fittings can be installed and if they are, one shot of grease is sufficient. If the bearing is over-greased, the seal may blow out, allowing dust, dirt and moisture to get into the seal, thus causing failure. **Lubricate the bearing every 24 to 32 operating hours.** Take out grease fitting/and reinstall plug.

NOTE: Check for debris build up between rotor and frame. Also watch out for foreign material like wire. Wire can work its way to the outside of rotor and get wedged between rotor and rotor bearing. Possible bearing damage may occur.

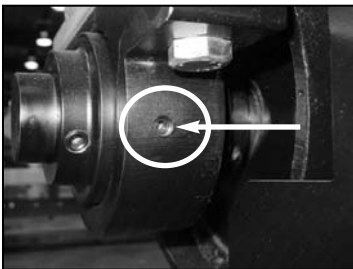

Rotor Bearing Grease Fitting

Clean all around plug. Remove rotor bearing housing plug, install grease fitting, pump with one shot of grease, remove grease fitting and reinstall plug.

Do NOT over grease! Over greasing may blow out seal, causing bearing failure.

NOTE: After Greasing Bearings Remove Grease Fitting

Manufacturer recommends removing grease fitting and installing plug for the following reasons:

Being a ground engaging area, damage could occur and dirt could get into the bearing causing bearing failure.

Also, service personal or operator not knowing, could over grease bearing causing seal damage.

DRIVE CHAIN

The PSS Series and PSHD Series of Power Rakes have two different chain drive assemblies. The PSS Series has a single #80 chain drive and the PSHD Series has a double #80 chain drive.

Lubricate chain every 15 to 20 hours. Use a high quality chain lube. Check chain tension spring for stretching. If spring is stretched out, replace the spring by removing cotter keys and removing the washer. Replace spring.

The drive chain should be inspected weekly. New chain has a tendency to stretch, so it is necessary to check the chain tension to prevent the chain from flopping around, thus causing potential problems.

Chain tension is preset with extension spring. If the chain becomes excessively loose, it may be necessary to remove one link (two pitches). If unable to reassemble, add an offset link (half link) to lengthen the chain.

When being stored for a long period or at the end of the season, remove drive chain, clean and then soak in oil for 24 hours, reinstall on machine.

See chaincase instructions – next page.

OWNER SERVICE (continued)

OPENING/CLOSING CHAIN CASE

When it is time to lubricate or adjust the drive chain, it works best to do the following:

1. Have the power unit connected to the power rake or place the power rake under a hoist so you can raise the unit off the ground (4" – 6"). Always place good wood blocking under the rotor bearings for safety. Shut the engine off, set the parking brake, and remove ignition key.
 - A. **NOTE:** On hydraulic powered rakes, relieve pressure before uncoupling couplers. Disconnect the hydraulic lines from your power unit and connect the two ends to each other. This should permit the rotor to rotate by hand.

On PTO powered rakes, disconnect the PTO driveline from the power unit. This will permit the rotor to rotate by hand.

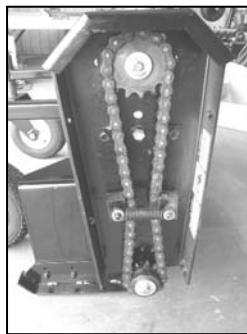

Guard is removed to show mechanical function.



Avoid injury – before removing any guard, shut the engine off and remove the ignition key.

NOTE: Replacement chain should be only high quality original equipment chain for longer life.

2. Remove the chain case cover by removing the six (6) 3/8" bolts on the sides of the cover.
3. Clean the drive chain and the inside of the chain case of dirt/debris. Clean the outer sides of the chain case. Clean the outer cover also. Be careful when cleaning; try not to damage the foam weather stripping on the chain case.
4. Check the tension of the drive chain. If it is too loose, then consider removing a half link or replacing the spring. If the tension is good – skip to #7.
5. If the spring is stretched out, replace the spring by removing the cotter pins and the washer. Replace with a new spring and re-assemble the washer and cotter pins.
6. If the chain is worn enough to remove a half link from the drive chain, then rotate (by hand) the rotor until the master link of the drive clam is on the bottom of the sprocket on the rotor shaft. Remove cotter pins (or special clip) from the drive chain master link.

Remove the master link. If the drive chain has a half link, remove it. If the drive chain does not have a half link, then remove a full link and add a half link.

Attach the ends of the chain with the master link and lock in place with the two cotter pins (or special clip).

7. Lubricate the drive chain with a quality chain lube. Use a 1" wide paint brush and coat all of the drive chain with oil.
8. Check the foam weather strips on the chain case. If they are damaged, scrape them off and replace with new. The weather stripping is 3/8" x 3/16" (9.52mm x 4.76mm) with a self-adhesive back and is available at most hardware or home improvement centers.
9. Align the cover with the bolt holes and re-install the six (6) 3/8" bolts. (Install all the bolts before tightening) pull up on the cover and tighten the bolts.

OWNER SERVICE (continued)

CHECK TIRE PRESSURE

Adjust the tire pressure in the gauge wheel tires to 20 psi. Keep tire valves capped.

ROTOR REPLACEMENT

NOTICE: It will be necessary to have a lifting device or additional help while removing and replacing the rotor.

(1) Take the side shields off. (2) Remove the chain case cover. (3) Take off the cotter pin and washer. (4) Release the chain tension. (5) Remove either the half link or the master link and split the chain. (6) Remove the bearing mount by removing the bearing mount bolts, one on the front and one on the back of each side. (7) Lift the main frame of the rake and move away from the rotor assembly.

To put the rotor back on, reverse above procedure.

The non-drive end of the rotor has bearing protectors installed on each side of the bearing. The outside protector is cam-locked to the inner bearing race and has set screws tightened to the rotor shaft. Loosen the set screws and remove from the bearing the same as removing as a regular bearing cam-lock collar.

The bearing protector between the bearing and rotor is fastened to the rotor shaft with set screws.

Cleaning the rotor shaft with emery cloth and filing down any set screw marks on the rotor shaft will make removal/installation of the bearing and protectors much easier.

HYDRAULIC HOSES & COUPLERS

Relieve pressure before uncoupling hydraulic couplers. Not relieving pressure could make recoupling difficult or impossible.

Disconnect the hydraulic lines from your prime mover and connect the two ends to each other. This should permit the rotor to rotate freely and keep the couplers clean.



Keep hydraulic fittings off the ground to prevent damage and collecting dirt and foreign material.

Cleaning off hydraulic tips before coupling is very important so you don't contaminate the hydraulics with dirt. Even though hydraulic system is turned off, there still could be hydraulic pressure in the system that could spray out when coupling and uncoupling. Always wear safety glasses and be careful.

If any damage occurs to hydraulic hoses, REPLACE IMMEDIATELY!

Use nylon ties to fasten hydraulic hose and keep it in place.

CHECK HYDRAULIC SYSTEM FOR LEAKS. SEE PROCEDURE BELOW.

WARNING!



Escaping fluid under pressure can have sufficient force to penetrate the skin, causing serious personal injury. Fluid escaping from a very small hole can be almost invisible. Use a piece of cardboard or wood, rather than hands to search for suspected leaks.

Keep unprotected body parts, such as face, eyes, and arms as far away as possible from a suspected leak. Flesh injected with hydraulic fluid may develop gangrene or other permanent disabilities.

If injured by injected fluid, see a doctor at once. If your doctor is not familiar with this type of injury, ask him or her to research it immediately to determine proper treatment.

TROUBLE-SHOOTING GUIDE

PROBLEM	POSSIBLE CAUSE	POSSIBLE REMEDY
Rake does not sit properly on skid steer attachment plate.	1. Obstruction between rake attachment plate and skid steer.	Check to see that the attachment plate is free of foreign obstacles. Make sure attachment plate pins are fully retracted when connecting.
Rotor will not turn.	1. Auxiliary hydraulic hoses not connected.	Connect hoses. (See Installation/Removal.)
	2. Auxiliary hydraulics not engaged.	Turn on auxiliary hydraulics.
	3. Air in hydraulic lines.	Cycle skid-steer auxiliary system several times to remove air from lines.
	4. Obstruction in hydraulic lines.	Replace obstructed or damaged line.
	5. Obstruction between rotor and material bar.	Reverse rotor to clear obstruction.
	6. Chain off.	Repair or replace chain.
	7. Relief valve setting on skid-steer not properly adjusted.	Have skid-steer dealer set relief valve at correct pressure.
	8. Worn, damaged, insufficient, or inadequate pump.	Repair or replace hydraulic pump.
	9. Insufficient oil in system.	Service the skid-steer hydraulic reservoir.
	10. Hose ends not completely engaged.	Check hose coupling and engage properly.
	11. Sheared or missing drive key in sprocket.	Replace key – check shaft for damage.
Oil leaks.	1. Worn or damaged seal.	Replace leaking seal.
	2. Loose or damaged hoses.	Replace damaged hoses and secure loose hoses.
	3. Loose or damaged connections.	Replace damaged hose connections and tighten loose fittings.

TROUBLE-SHOOTING GUIDE (continued)

PROBLEM	POSSIBLE CAUSE	POSSIBLE REMEDY
Machine makes intermittent clicking noise.	1. Loose parts.	Check that all nuts and bolts are properly tightened.
	2. Drive chain damaged or worn.	Replace damaged chain.
	3. Chain tightener spring broke or disconnected.	Repair or replace spring.
Operating depth insufficient.	1. Gauge wheels too low.	Raise gauge wheels.
	2. Rotor rpm too slow.	Increase skid steer RPM or adjust hydraulic flow to motor.
	3. Build up of dirt on rotor.	Clean rotor.
Rotor gouging on one end during finish pass.	1. Machine not properly adjusted for soft soil conditions.	The gauge wheel on the chain case side should be approximately 1" lower than the non-drive gauge wheel for consistent leveling.
	2. Gauge wheels not adjusted properly.	Adjust gauge wheels.
	3. Gauge wheel tires do not have the same air pressure.	Check tires for correct air pressure.
Too much dirt going into the windrow or dirt going over the top of the material control bar.	1. Operating too fast.	Reduce ground speed.
	2. Material bar set too low.	Raise material bar.
	3. Gauge wheels set too high.	Lower gauge wheels.
Too many rocks passing between material control bar and the rotor.	1. Material bar set too high.	Lower material bar.

TROUBLE-SHOOTING GUIDE (continued)

PROBLEM	POSSIBLE CAUSE	POSSIBLE REMEDY
Hydraulic hose failure.	1. Hose being pinched.	Reroute hose and fasten out of harms way.
	2. Hoses worn or frayed.	Replace hose.
	3. Hydraulic relief pressure on power unit too high.	Adjust relief pressure (if possible) or change power unit.
<hr/>		
Rotor balling up with soil.	1. Soil too wet.	Wait until soil dries.
<hr/>		
Excessive vibration and/or machine jumps over ground.	1. Excessive trash wrapped on rotor.	Remove trash (clean rotor).
	2. Rotor speed not correct.	Increase rotor speed if turning slow.
		Decrease rotor speed if turning too fast.
	3. Hard ground.	Wait for rain.
4. Damaged or bent main rotor.	Replace rotor.	
<hr/>		
Drive chain breaks.	1. Drive chain not properly tightened.	Repair or replace chain tightener spring.
	2. Drive chain is rusted and has been setting outside.	Replace chain and lubricate regularly.
	3. Operator is dropping rotating rotor rapidly into hard ground.	Retrain operator.
	4. Operator is rapidly changing rotor direction.	Retrain operator and reread instructions.
	5. Rotor hitting large rocks or stumps.	Check work area before operating.
<hr/>		
Excessive tooth breakage.	1. See #3 above.	Same as above.
	2. See #5 above.	Same as above.

TROUBLE-SHOOTING GUIDE (continued)

PROBLEM	POSSIBLE CAUSE	POSSIBLE REMEDY
Angle cylinder will not extend or retract.	1. Electrical failure.	See skid-steer Operator's Manual.
	2. Broken wire.	Replace or repair wire.
	3. Electric connections not making contact.	Check wiring harness and switch connections.
	4. Hydraulic system not activated.	Engage rotor drive motor before attempting to move angle cylinder.
Angle cylinder will not hold position.	1. Check valve in manifold malfunctioning.	Repair or replace check valve.
	2. Solenoid cartridge not returning to closed position.	Repair or replace solenoid cartridge.

PSS SERIES FRAME PARTS

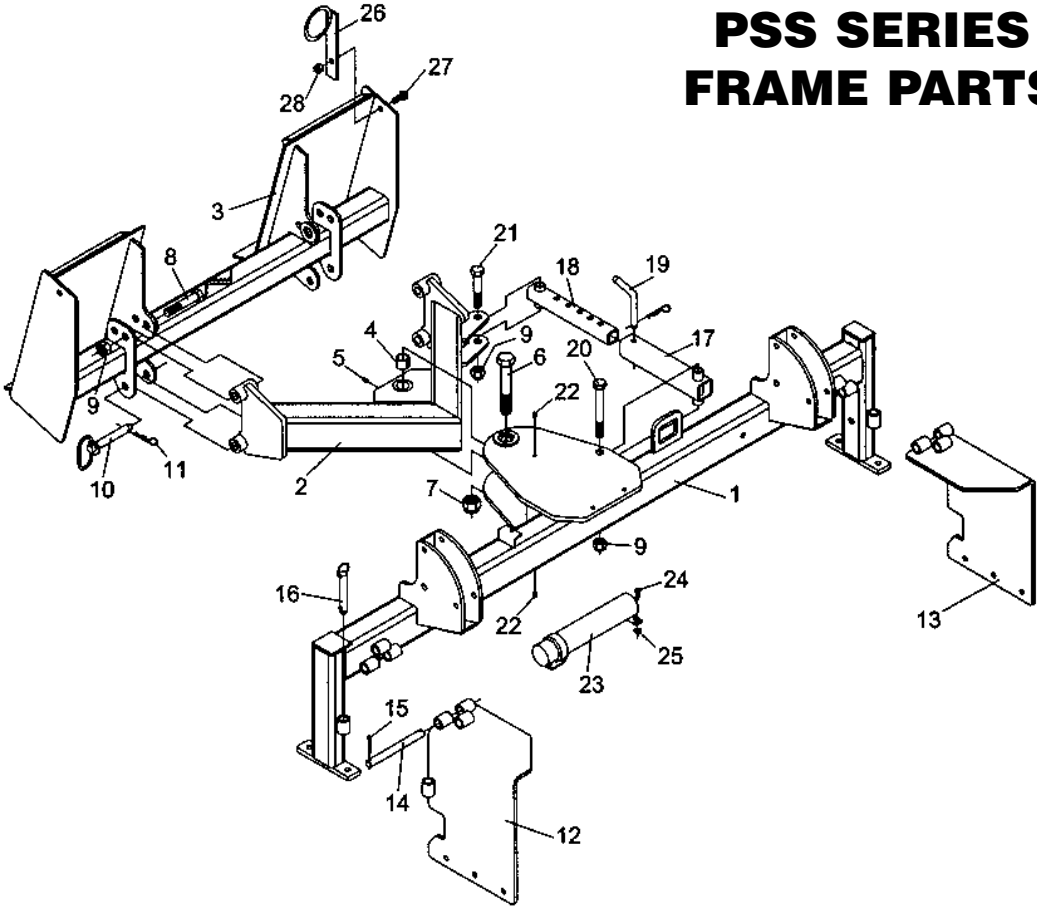

Ref. No.	Part No.	Description	No. Req'd.
1	360858	PSS-620 Main Frame Weldment	1
	360856	PSS-720 Main Frame Weldment	1
2	360841	'A' Frame Weldment, PSS Flex & Float	1
3	360835	Mount Weldment, PSS Flex & Float	1
4	2505035	Bushing, Spring 1" ID x 1" Lg.	2
5	2504049	Zerk, Drive 5/16"	1
6	2503257	Bolt 1"-8NC x 6" Hex Head Gr. 5	1
7	2500045	Nut 1"-8NC Hex Nylock	1
8	2503137	Bolt 3/4"-10NC x 4" Hex Head Gr. 5	2
9	2500037	Nut 3/4"-10NC Hex Nylock	4
10	590163	Pin, Hitch w/Handle (AK-3000)	2
11	590188	Hair Clip Pin 5/32" (AK-2705)	2
12	360796	Shield, RH Side	1
13	360798	Shield, LH Side	1
14	3814014	Pin, Shield Hinge	2
15	2504121	Cotter Pin 3/16" x 1 1/2"	4
16	2504269	Pin, Spring Ball	2
17	360832	Tube, Outer Adjustment	1
18	360834	Tube, Inner Adjustment	1
19	343180	Pin, Shift	1
20	2503035	Bolt 3/4"-10NC x 6" Hex Head Gr. 5	1
21	2503137	Bolt 3/4"-10NC x 4" Hex Head Gr. 5	1
22	2504178	Zerk, Grease 1/4"-28NF	2
23	2504225	Manual Holder, Plastic	1
24	2503094	Bolt 5/16"-18NC x 3/4" Hex Head Gr. 2	2
25	2500060	Nut 5/16"-18NC Whiz Flange Hex	2
26	360543	Skid Steer Hose Support Weldment	1
27	2503026	Bolt 1/2"-13NC x 1 1/4" Hex Head Gr. 2	1
28	2500039	Nut 1/2"-13NC Nylock Hex	1

PSS SERIES DRIVE SYSTEM

ITEM NO.	QTY.	PART NO.	DESCRIPTION
1	2	2504267	Pin Cotter 1/8 X 1
2	6	2503343	Bolt, HCS 3/8-16 X 1.0 Flange Hd.
3	2	2503026	Bolt, HCS 1/2-13 X 1.25
4	2	2503118	Bolt, HCS 1/2-13 X 2.0
5	2	2500093	Nut, Nylock 7/16-14
6	2	2500039	Nut, Nylock 1/2-13
7	2	2500039	1/2 Nylock Nut
8	2	2505780	Adapter Hyd, - Straight Conn. 7/8" to 1 1/16"
9	1	2502007	5/8 Split Lock Washer
10	1	2501038	Washer Jumbo 5/8 I.D. (Hyd. Motor)
11	1	2502002	1/2 Split Lock Washer
12	1	2501037	Washer, Jumbo 1/2 I.D. (Rotor Shaft)
13	1	2503344	Bolt, HCS 1/2-20 X 1.50
14	1	HAR8013064	Spring, Chain Tensioner 1" X 4" Special
15	2	2501027	Washer, Flat 12MM
16	1	2505759	Hyd. Motor-15 gpm (Parker)
17	1	2505770	Key .31 X 1.25 Lg.
18	1	2505771	Key .38 X 1.25 Lg.
19	2	NTM1003019	Chain Tightner - UHMW BLOCK
20	1	NTM1003022	Bushing, Rotor Shaft Wide
21A1	2	2505781	Hose, Hyd. - 5/8" X 84"
22	2	NTW1003003	Chain Tightener Arm (7/16" bolt)
23	1	NTW1003004	Chain Case
24	1	NTW1003005	Chain Case Cover
25	1	RCN1018041R	Chain #80 W/Connector and Offset (51 Pitch)
26	1	RCN41802012HK	Sprocket #80 12T 1.25 Bore 5/16 Key
27	1	RCN41802414H	Sprocket #80 14T 1.50 Bore
28	1	2505659	Coupler, Flat Face - 3/4" ORB Female
29	1	2505660	Coupler, Flat Face - 3/4" ORB Male
NS	1	2506026	Offset Link #80 (Half Link)
NS	1	2506025	Connector Link #80 (Master Link)
NS	6	Purchase Locally	Weather Stripping - 3/8" x 3/16" w/Self-adhesive back

PSS MATERIAL BAR

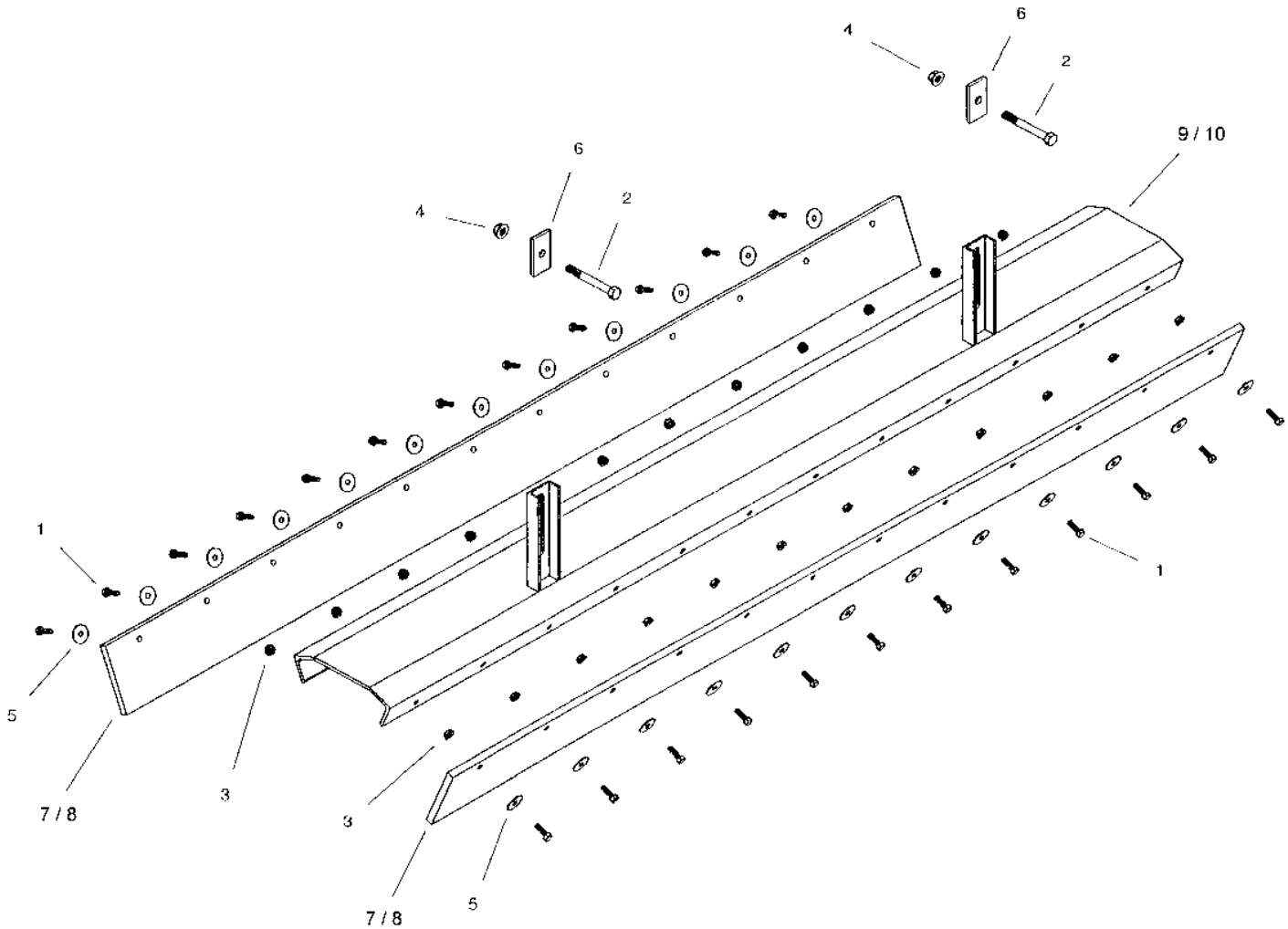

<u>ITEM NO.</u>	<u>QUANTITY</u>	<u>PART NO.</u>	<u>DESCRIPTION</u>
1	VARIES	2503038	BOLT HCS 5/16 X 1
2	2	2503317	BOLT, HCS 1/2 - 13 X 4.5" LONG
3	VARIES	2500060	5/16 FLANGE SERRATED LOCK NUT
4	2	2500040	NUT, FLANGE SERRA 1/2 - 13
5	VARIES	2501035	WASHER, FENDER 5/6 X 1 1/4
6	2	NTM1005001	WASHER, MATERIAL BAR ADJUSTING
7	2	NTM1005013	RUBBER STRIP 6' 1/2" x 4" x 71.5"
8	2	NTM1005014	RUBBER STRIP 7' 1/2" X 4" X 83.5"
9	1	360847	MATERIAL BAR, 6FT. DOUBLE
10	1	360867	MATERIAL BAR, 7FT. DOUBLE
		360846	6' COMPLETE ASSEMBLY EXCEPT 2,4,6
		360867	7' COMPLETE ASSEMBLY EXCEPT 2,4,6

PSS GAUGE WHEEL

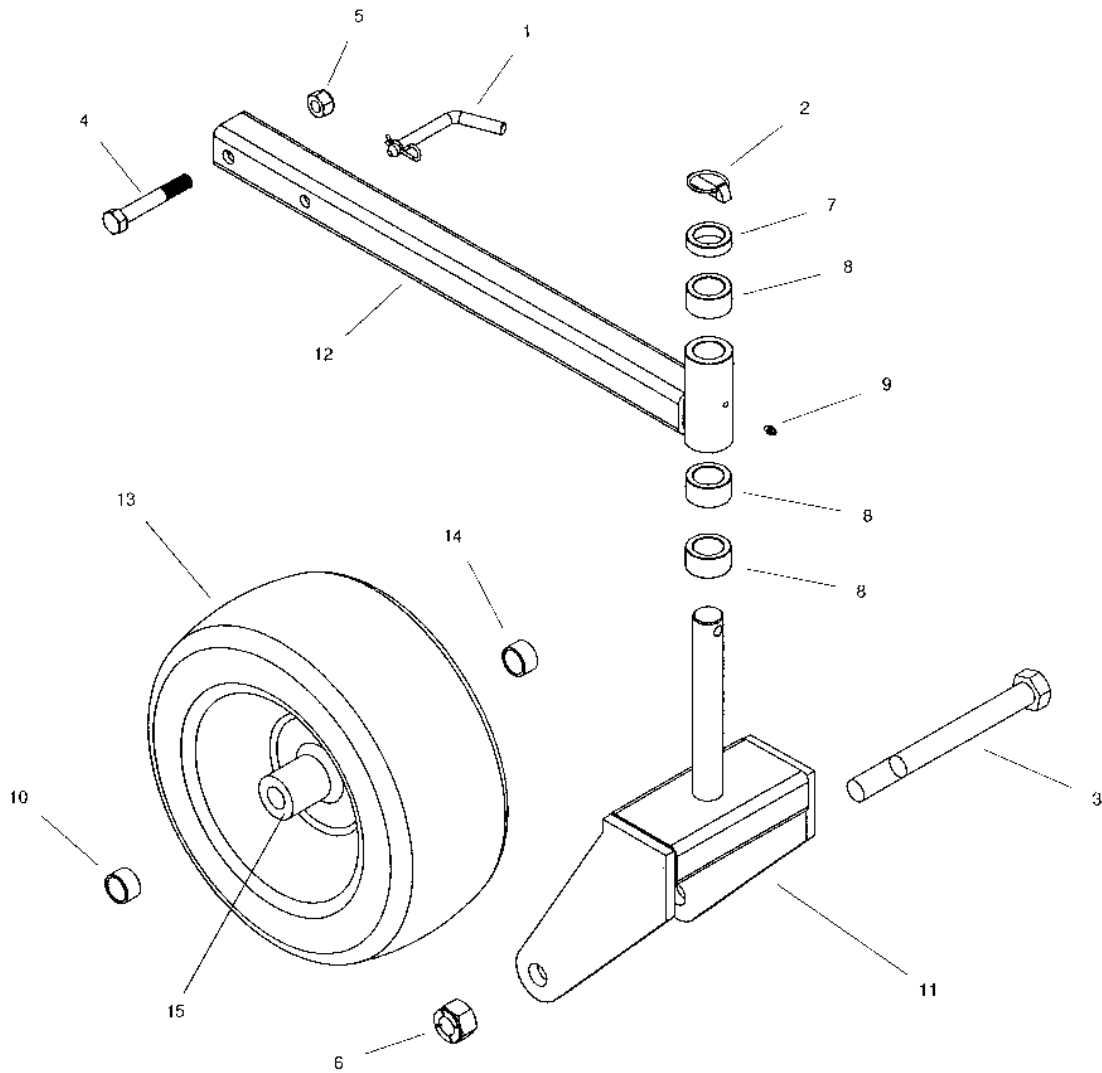

ITEM NO.	QTY.	PART NO.	DESCRIPTION
1	1	343180	BENT HITCH PIN 1/2 x 3.0
2	1	590006	LYNCH PIN 7/16
3	1	2503312	BOLT, HCS 1.0" x 10.0" LONG
4	1	2503144	BOLT, HCS 5/8 - 11 X 3/5"
5	1	2500041	NUT NYLOCK 5/8 -11
6	1	2500045	NUT NYLOCK 1 x 8 NC
7	1	NTM1007032	1/2" SPACER, GAUGE WHEEL
8	3	NTM1007028	1" SPACER, GAUGE WHEEL
9	1	2504049	GREASE FITTING, 5/16 DRIVE
10	1	360303	SPACER, AXLE - 1.0 I.D. x 1.56" LONG
11	1	NTW1007003	YOKE, LARGE GAUGE WHEEL
12	1	NTW1007005	ARM, 27" GAUGE WHEEL
13	1	2506032	TIRE/RIM 16 x 6.50 - 8
14	1	360304	SPACER, AXLE 1.0 I.D. x 2.56" LONG
15	1	2506033	HUB, 4 BOLT w/BEARINGS & SEALS

PSHD SERIES 3 PT. MOUNT, FRAME / SIDE SHIELD PARTS

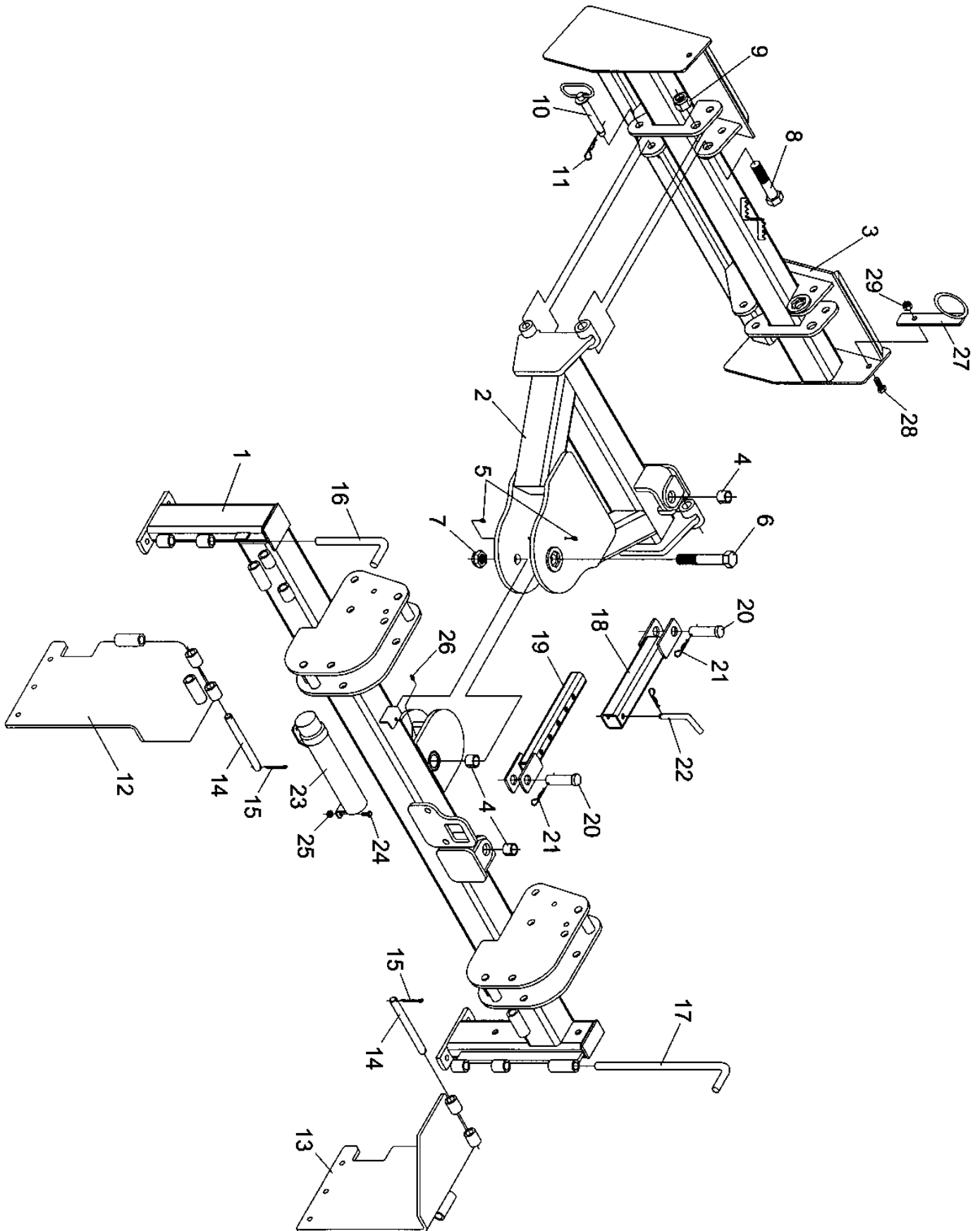

PSHD SERIES 3 PT. MOUNT, FRAME / SIDE SHIELD PARTS

Ref. No.	Part No.	Description	No. Req'd.
1	360561	PSHD-665 Main Frame Weldment	1
	360643	PSHD-765 Main Frame Weldment	1
	360581	PSHD-865 Main Frame Weldment	1
2	360740	'A' Frame Weldment, PSHD Flex & Float	1
3	360745	Mount Weldment, PSHD Flex & Float	1
4	2505035	Bushing, Spring 1" ID x 1" Lg.	4
5	2504271	Grease Zerk 1/4"-28NF - 45°	2
6	2503257	Bolt 1"-8NC x 6" Hex Head Gr. 5	1
7	2500085	Nut 1"-8NC Hex Jam Nylock	1
8	2503108	Bolt 1"-8NC x 4 1/2" Hex Head Gr. 5	2
9	2500045	Nut 1"-8NC Hex Nylock	2
10	590163	Pin, Hitch w/Handle (AK-3000)	2
11	590188	Hair Clip Pin 5/32" (AK-2705)	2
12	360340	Shield, RH Side	1
13	360345	Shield, LH Side	1
14	3814014	Pin, Shield Hinge	2
15	2504121	Cotter Pin 3/16" x 1 1/2"	4
16	360559	Shield Locking Pin 9"	1
17	360558	Shield Locking Pin 19 1/4"	1
18	360356	Adjustable Link, Female	1
19	360358	Adjustable Link, Male	1
20	863070	Cylinder Pin	2
21	590097	Clip Pin 3/16" (SC-175)	2
22	343180	Pin, Shift (1/2" x 3") w/Clip Pin	1
23	2504225	Manual Holder, Plastic	1
24	2503094	Bolt 5/16"-18NC x 3/4" Hex Head Gr. 2	2
25	2500060	Nut 5/16"-18NC Whiz Flange Hex	2
26	2504049	Grease Zerk, 5/16" Drive	1
27	360543	Skid Steer Hose Support Weldment	1
28	2503026	Bolt 1/2"-13NC x 1 1/4" Hex Head Gr. 2	1
29	2500039	Nut 1/2"-13NC Nylock Hex	1

PSHD CHAINCASE and DRIVE PARTS

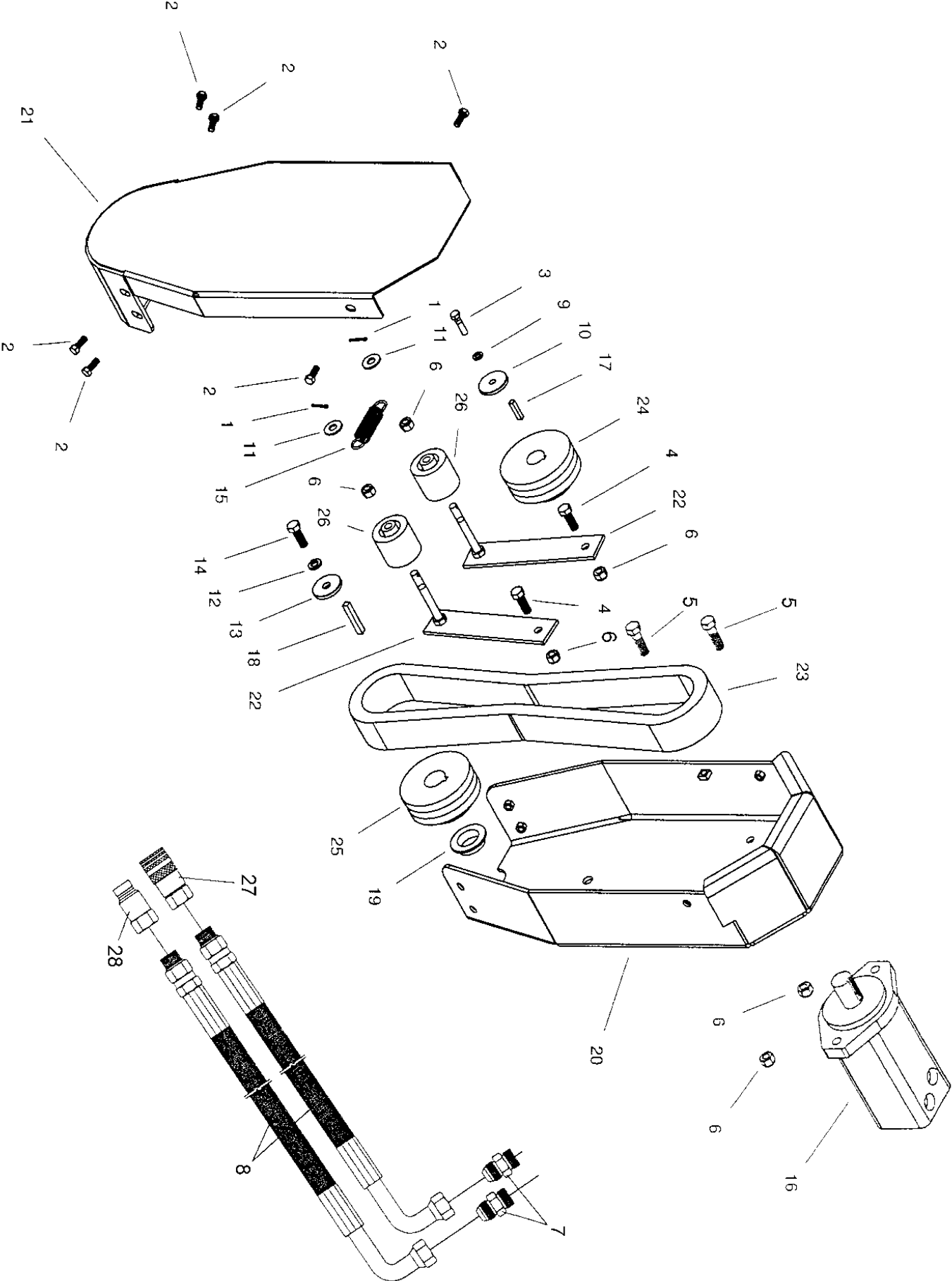

PSHD CHAINCASE and DRIVE PARTS

Item Number	QTY	Part Number	Description
1	2	2504267	Pin, Cotter 1/8 x 1
2	6	2503343	Bolt, HCS 3/8 - 16 x 1.0 Flange Head
3	1	2503346	Bolt, HCS 5/8 - 18NF x 1.50
4	2	2503026	Bolt, HCS 1/2 - 13 x 1.25
5	2	2503118	1/2 Hex Head Bolt 2.0" Lg
6	6	2500039	Nut, Nylock 1/2 - 13
7	2	2505780	Adapter, Hyd. - Straight Conn. 7/8" to 1-1/16"
8	2	2505781	Hose, Hyd. - 5/8" x 84"
9	1	2502007	5/8" Split Lockwasher
10	1	360307	Retainer, 80-2 Sprocket
11	10	2501027	Washer, Flat 11 mm
12	1	2502002	1/2 Split Lock Washer
13	1	2501037	Washer, Jumbo 1/2" x 2.0"
14	1	2503344	Bolt, HCS 1/2 - 20 x 1.50
15	1	HAR8016096	Spring Chain Tensioner 1" x 6" Special
16	1	2505760	Hyd. Motor, Parker (20 cubic in.)
17	1	2505772	Key .31 x 1.63 Lg
18	1	2505773	Key .38 x 2.0 Lg
19	1	NTM1003021	Bushing, Rotor Shaft Narrow
20	1	NTW1003007	Chain Case, H.D.
21	1	NTW1003008	Chain Case Cover
22	2	NTW1003009	Chain Tightener Arm
23	1	360597	Chain, #80 Double (58 pitch) Assembly
24	1	RCN42802014HK	Sprocket, #80 Double 14T 1.25 Bore 5/16 Keyway
25	1	RCN42802414H	Sprocket, #80 Double 14T 1.50 Bore 3/8 Keyway
26	2	360578	Chain Idler Roller (UHMW)
27	1	2505659	Coupler, Flat Face - 3/4" ORB Female
28	1	2505660	Coupler, Flat Face - 3/4" ORB Male
NS	1	2506027	Connector #80D (Master Link)
NS		2506028	Offset Link #80D (Half Link)
NS	6	Purchase Locally	Weather Stripping - 3/8" x 3/16" w/Self-adhesive back

PSHD MATERIAL BARS

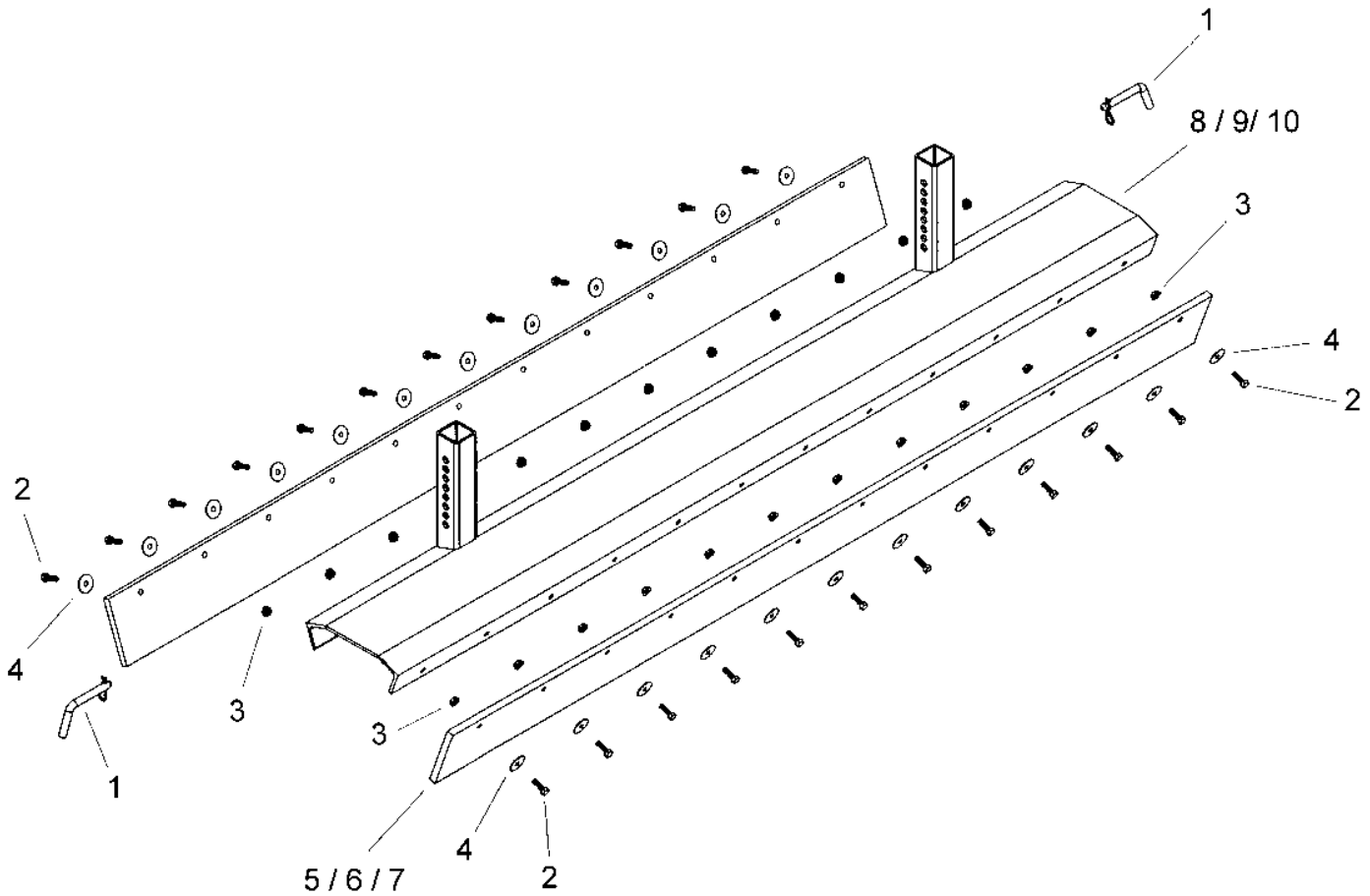

ITEM NUMBER	QTY.	PART NUMBER	DESCRIPTION
1	2	343180	Pin, Bent Hitch 1/2" X 3.0" w/Clip
2	Varies	2503038	Bolt, HCS 5/16" X 1.0"
3	Varies	2500060	Nut, 5/16 Serrated Flange
4	Varies	2501035	Washer, 5/16" Fender
5	2	NTM1005013	Rubber Strip, 6ft. 1/2" X 4" X 71.5"
6	2	NTM1005014	Rubber Strip, 7ft. 1/2" X 4" X 83.5"
7	2	NTM1005032	Rubber Strip, 8ft. 1/2" X 4" X 95.5"
8	1	NTW1005011	Bar Weldment, 6ft. Material Double
9	1	NTW1005010	Bar Weldment, 7ft. Material Double
10	1	360784	Bar Weldment, 8ft. Material Double
		360593	6ft. Complete Material Bar Assembly
		360780	7ft. Complete Material Bar Assembly
		360783	8ft. Complete Material Bar Assembly

PSHD GAUGE WHEEL

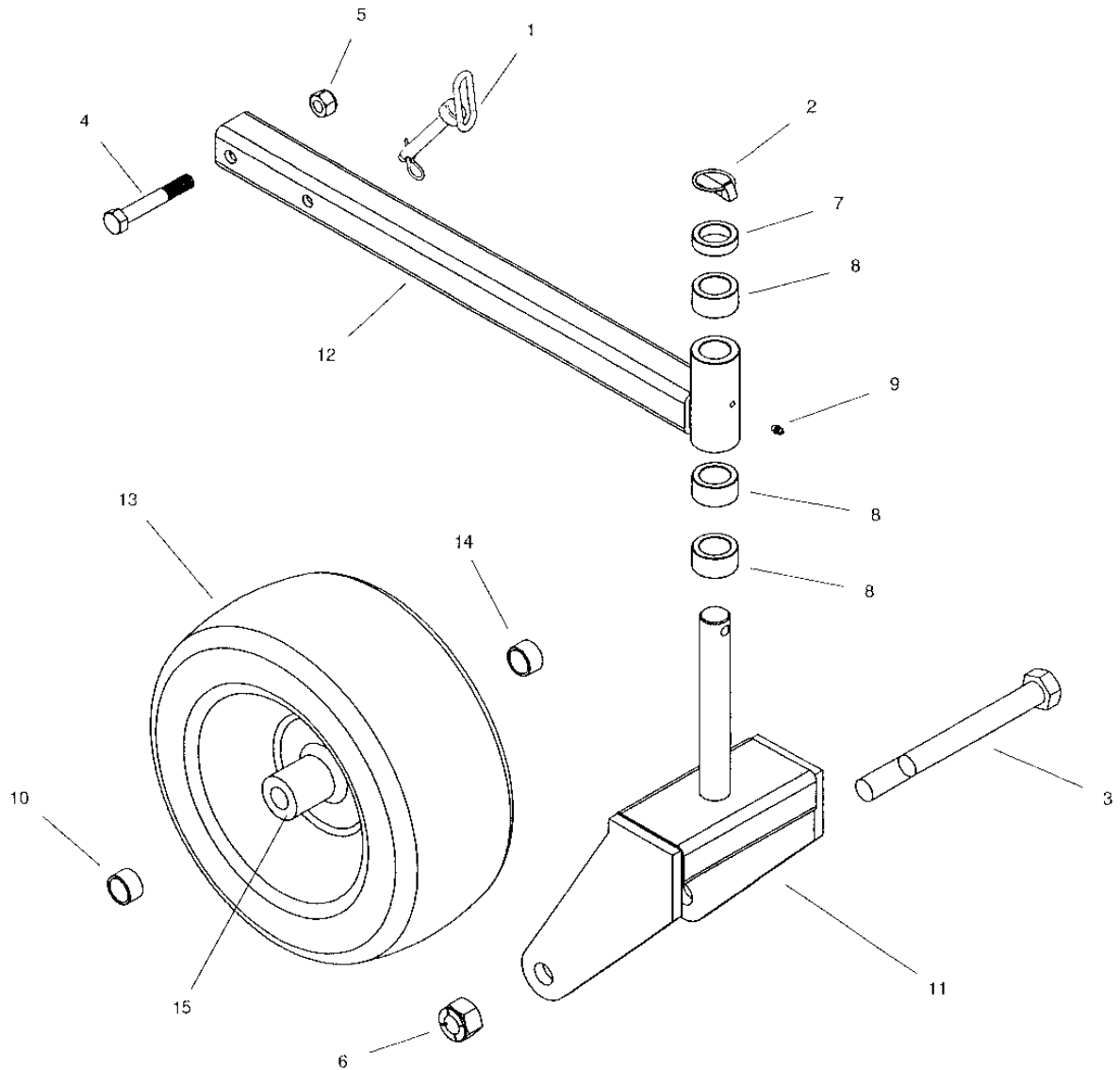

Item Number	QTY	Part Number	Description
1	1	590163	Hitch Pin, 3/4" x 4-1/4" w/Clip
2	1	590006	Lynch Pin 7/16"
3	1	2503321	Bolt, HCS 1-8 x 12.0"
4	1	2503137	Bolt, HCS 3/4" x 4.5
5	1	2500037	Nut, Nylock 3/4" – 10NC
6	1	2500045	Nut, Nylock 1-8
7	1	NTM1007017	Spacer 1/2 x 1.51 I.D.
8	3	NTM1007016	Spacer 1.00 x 1.51 I.D.
9	1	2504049	Grease Fitting, 5/16" Drive
10	1	811979	Spacer, Axle 3.25" Long
11	1	360533	Yoke, H.D. Gauge Wheel
12	1	360546	Arm, H.D. Gauge Wheel
13	1	811977	Tire/Rim 18.5 x 8.5 - 8
14	1	811978	Spacer, Axle 2.75" Long
15	1	811976	Hub Assembly, 5 Bolt w/Bearings & Seals

PSS and PSHD SERIES ROTORS

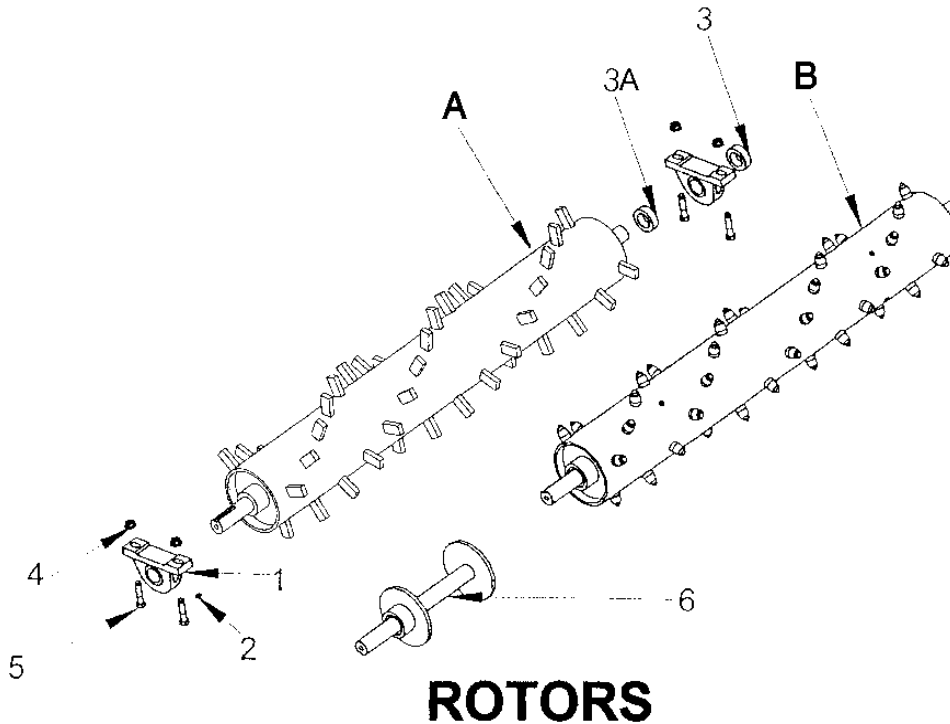

(A) SABRETOOTH SPIRAL PATTERN

5 ft. 360624
 6 ft. 360629
 7 ft. 360594
 8 ft. 360599

Individual Sabre Tooth
 #NTM1004015

(B) AGGRESSOR SPIRAL CARBIDE TOOTH PATTERN

5 ft. 360609
 6 ft. 360614
 7 ft. 360576
 8 ft. 360584

Individual Carbide Tooth
 #NTK1004032

OTHER ROTOR PARTS

ITEM#	QUANTITY	PART #	DESCRIPTION
1	2	BRG 124L43D	Bearing, Special 1 1/2" Pillow Block
2	2	2504268	Plug, 1/8 NPT (for grease zerk hole)
2A	2	2504014	Zerk, 1/8 NPT Grease (Not Shown)
3	2	BRG 600080T	1 1/2" Eccentric Bearing Protector (Non-drive end only)
3A	1	360536	1 1/2" Bearing Protector - Non-Cam (Non-drive end only)
4	4	2500102	Nut, 1/2 - 13 NC Flange Locknut
5	4	2503118	Bolt, 1/2 - 13NC X 2.0"
6	1	NTW1004003	Drive End Shaft Assembly (Welding required)

OPTIONAL HYDRAULIC ANGLE ADJUSTMENT KIT

For PSS Model Power Landscape Rakes
Kit #360779

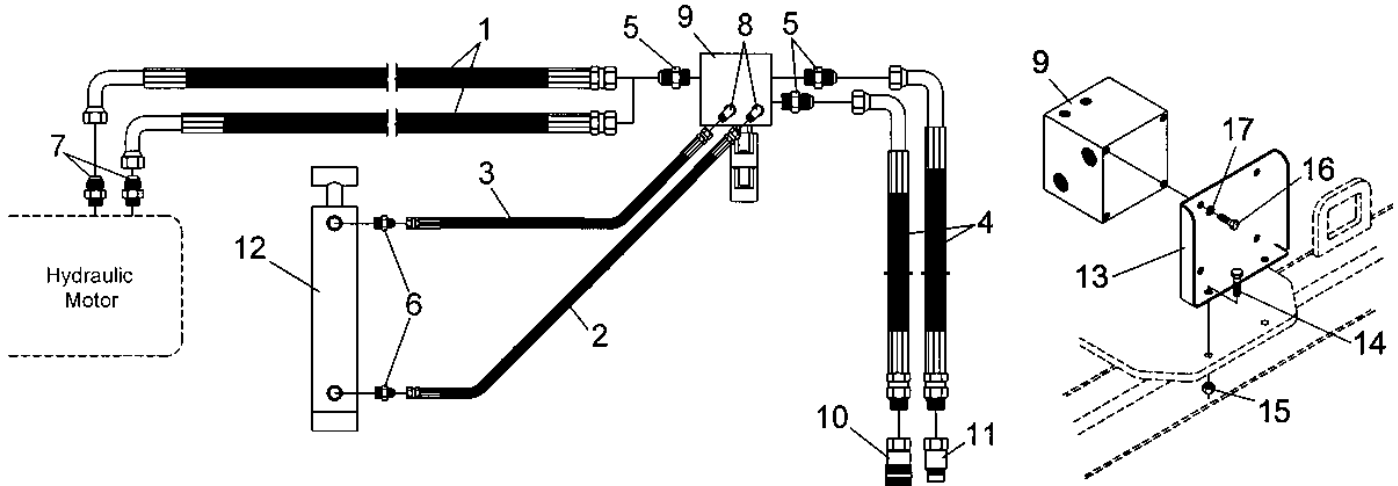

NOTE: Part No. 360327 Switch and Wiring Harness Assembly shown on page 59 is included in the Opt. Hyd. Angle Adj. Kit shown on this page.

Ref. No.	Part No.	Description	No. Req'd.
1	2505777	Hydraulic Hose 5/8" x 36"	2
2	2505778	Hydraulic Hose 3/8" x 24"	1
3	2505779	Hydraulic Hose 3/8" x 16"	1
4	2505781	Hydraulic Hose 5/8" x 84"	2
5	2505651	Hydraulic Adapter - Straight Connector 1 1/16"	4
6	2505684	Hydraulic Adapter - Straight Connector 9/16" to 3/4"	2
7	2505780	Hydraulic Adapter - Straight Connector 7/8" to 1 1/16"	2
8	2505712	Hydraulic Adapter - 90° Adjustable Elbow 9/16"	2
9	HYD6012008	Hydraulic Control Valve Assembly w/Coils	1
10	2505659	Flat Face Coupler 3/4" ORB Female	1
11	2505660	Flat Face Coupler 3/4" ORB Male	1
12	HYD200320962	Hydraulic Cylinder 2 x 6	1
13	360522	Bracket, PSS Valve Mount	1
14	2503020	Bolt 3/8"-16NC x 1 1/4" Hex Head Gr. 2	2
15	2500004	Nut 3/8"-16NC Full Hex	2
16	2503038	Bolt 5/16"-18NC x 1" Hex Head Gr. 2	4
17	2502011	Washer 5/16" Spring Lock	4

OPTIONAL HYDRAULIC ANGLE ADJUSTMENT KIT

For PSHD Model Power Landscape Rakes

6' & 7' Kit #360864

8' Kit #360866

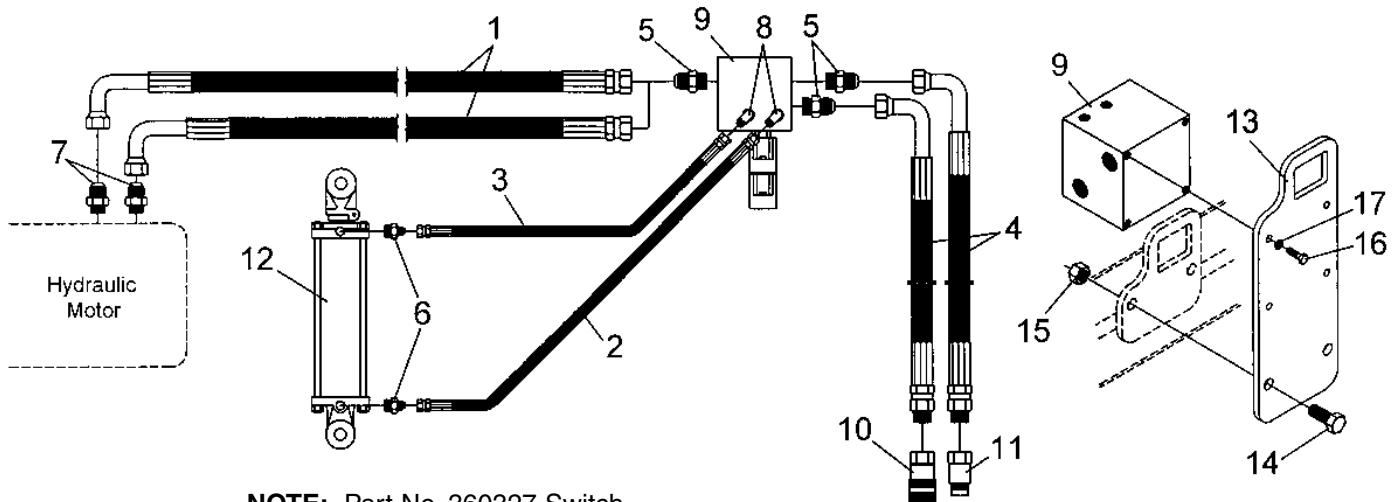

NOTE: Part No. 360327 Switch and Wiring Harness Assembly shown on page 59 is included in the Opt. Hyd. Angle Adj. Kit shown on this page.

Ref. No.	Part No.	Description	No. Req'd.
1	2505777	Hydraulic Hose 5/8" x 36" (6' & 7' Models)	2
	2505782	Hydraulic Hose 5/8" x 42" (8' Models)	2
2	2505778	Hydraulic Hose 3/8" x 24"	1
3	2505779	Hydraulic Hose 3/8" x 16"	1
4	2505781	Hydraulic Hose 5/8" x 84"	2
5	2505651	Hydraulic Adapter - Straight Connector 1 1/16"	4
6	2505684	Hydraulic Adapter - Straight Connector 9/16" to 3/4"	2
7	2505780	Hydraulic Adapter - Straight Connector 7/8" to 1 1/16"	2
8	2505712	Hydraulic Adapter - 90° Adjustable Elbow 9/16"	2
9	HYD6012008	Hydraulic Control Valve Assembly w/Coils	1
10	2505659	Flat Face Coupler 3/4" ORB Female	1
11	2505660	Flat Face Coupler 3/4" ORB Male	1
12	2504258	Hydraulic Cylinder 3 x 6	1
13	360591	Valve Mount Plate	1
14	2503047	Bolt 5/8"-11NC x 1 1/2" Hex Head Gr. 2	2
15	2500013	Nut 5/8"-11NC Full Hex	2
16	2503038	Bolt 5/16"-18NC x 1" Hex Head Gr. 2	4
17	2502011	Washer 5/16" Spring Lock	4

OPTIONAL HYDRAULIC SWING SOLENOID VALVE KIT WIRING DIAGRAM & PARTS LIST

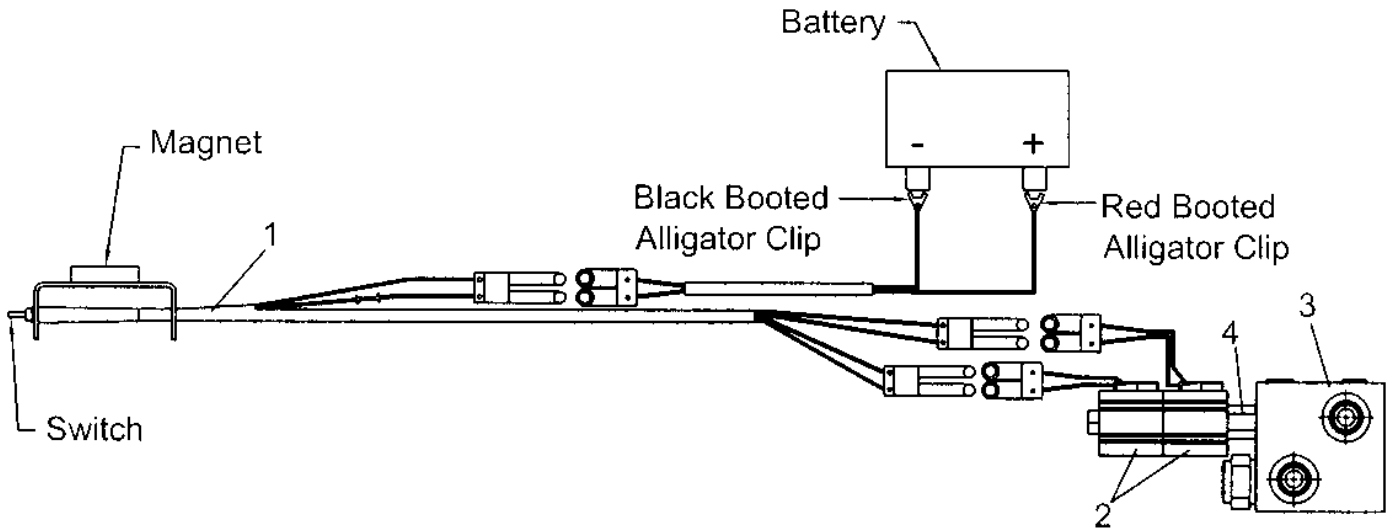

Ref. No.	Part No.	Description	No. Req'd.
1	360327	Switch and Wiring Harness Assembly	1
2	HYD6012004	Coil, Solenoid	2
3	HYD6012008	Valve Assembly (includes Coils)	1
4	HYD6012003	Cartridge, Solenoid	1

OPTIONAL SIDE SHIELD EXTENSION KIT

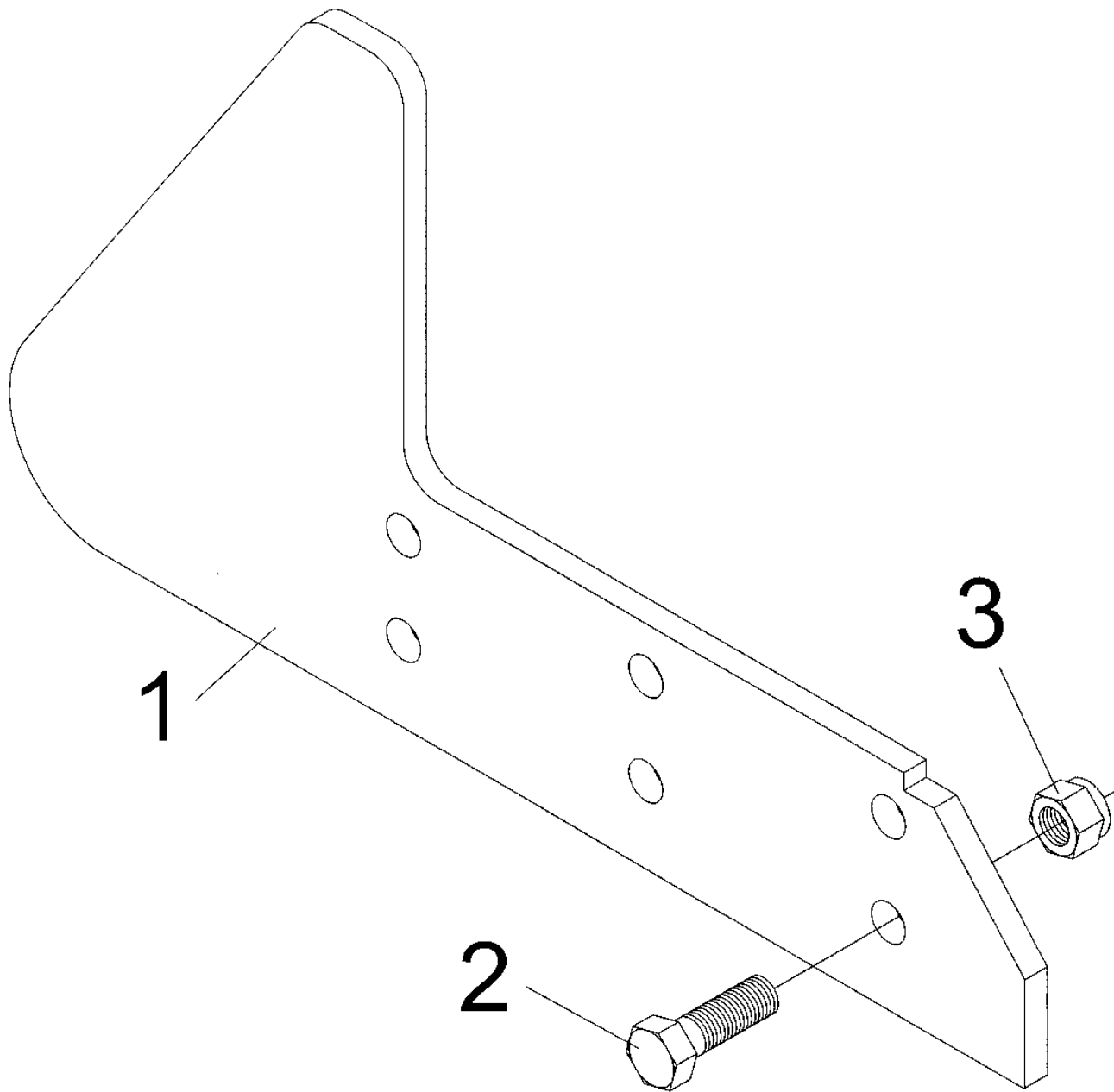

Ref. No.	Part No.	Description	No. Req'd.
	360985	Side Shield Extension Kit - Pair w/Hardware	
1	360969	HD Side Shield Extension	2
2	2503145	Bolt 1/2"-13NC x 1 1/2" Hex Head Gr. 5	6
3	2500039	Nut 1/2"-13NC Hex Nylock	6

BOLT TORQUE CHART

Always tighten hardware to these values unless a different torque value or tightening procedure is listed for a specific application.

Fasteners must always be replaced with the same grade as specified in the manual parts list.

Always use the proper tool for tightening hardware: SAE for SAE hardware and Metric for metric hardware.

Make sure fastener threads are clean and you start thread engagement properly.

All torque values are given to specifications used on hardware defined by SAE J1701 & J1701M JUL96.

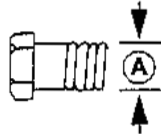

SAE SERIES TORQUE CHART



SAE Grade 2
(No Dashes)

SAE Bolt Head
Identification



SAE Grade 5
(3 Radial Dashes)



SAE Grade 8
(6 Radial Dashes)

A Diameter (Inches)	Wrench Size	MARKING ON HEAD					
		SAE 2		SAE 5		SAE 8	
		lbs-ft	N-m	lbs-ft	N-m	lbs-ft	N-m
1/4"	7/16"	6	8	10	13	14	18
5/16"	1/2"	12	17	19	26	27	37
3/8"	9/16"	23	31	35	47	49	67
7/16"	5/8"	36	48	55	75	78	106
1/2"	3/4"	55	75	85	115	120	163
9/16"	13/16"	78	106	121	164	171	232
5/8"	15/16"	110	149	170	230	240	325
3/4"	1-1/8"	192	261	297	403	420	569
7/8"	1-5/16"	306	416	474	642	669	907
1"	1-1/2"	467	634	722	979	1020	1383

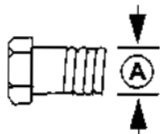

METRIC SERIES TORQUE CHART



Metric
Grade 8.8

Metric Bolt Head
Identification



Metric
Grade 10.9

A Diameter & Thread Pitch (Millimeters)	Wrench Size	COARSE THREAD				FINE THREAD				A Diameter & Thread Pitch (Millimeters)
		MARKING ON HEAD								
		Metric 8.8		Metric 10.9		Metric 8.8		Metric 10.9		
		N-m	lbs-ft	N-m	lbs-ft	N-m	lbs-ft	N-m	lbs-ft	
6 x 1.0	10 mm	8	6	11	8	8	6	11	8	6 x 1.0
8 x 1.25	13 mm	20	15	27	20	21	16	29	22	8 x 1.0
10 x 1.5	16 mm	39	29	54	40	41	30	57	42	10 x 1.25
12 x 1.75	18 mm	68	50	94	70	75	55	103	76	12 x 1.25
14 x 2.0	21 mm	109	80	151	111	118	87	163	120	14 x 1.5
16 x 2.0	24 mm	169	125	234	173	181	133	250	184	16 x 1.5
18 x 2.5	27 mm	234	172	323	239	263	194	363	268	18 x 1.5
20 x 2.5	30 mm	330	244	457	337	367	270	507	374	20 x 1.5
22 x 2.5	34 mm	451	332	623	460	495	365	684	505	22 x 1.5
24 x 3.0	36 mm	571	421	790	583	623	459	861	635	24 x 2.0
30 x 3.0	46 mm	1175	867	1626	1199	1258	928	1740	1283	30 x 2.0

Typical Washer Installations

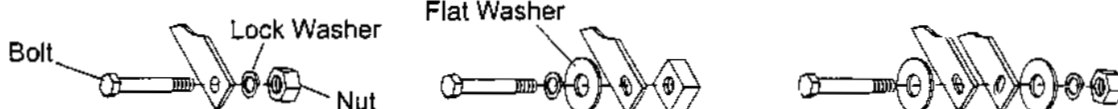

8/9/00

SAFETY REQUIREMENTS

AVOID ACCIDENTS BY FOLLOWING ALL OF THE SAFETY REQUIREMENTS LISTED BELOW.

- Machinery should be operated only by those who are responsible and are authorized to do so.
- Stop the engine, lower all equipment, lock the brakes, and remove the ignition key before dismounting from the skid steer.
- Never stand between skid steer and attachment while skid steer is being connected to the attachment.
- Loose fitting clothing should not be worn, to avoid catching on various parts.
- Detach attachment in area where children normally do not play.
- When performing adjustments or maintenance on an attachment, first lower it to the ground or block it securely at a workable height.
- Only a qualified operator should be permitted on skid steer when in operation; no riders allowed.
- Make certain everyone is in the clear before starting prime mover or raising or lowering equipment.
- Operate the skid steer and attachment only while in the operator's station.
- Reduce speed when transporting mounted attachments to avoid bouncing and momentary loss of steering control.
- A heavy load can cause instability of the skid steer. Use extreme care during road travel. Slow down on turns and watch out for bumps. Skid steer may need counterweights to counter-balance the weight of the attachment.
- Reduce speed on hillsides or curves so there is no danger of tipping.
- Avoid driving too close to the edge of ditches or drop offs.
- Do not transport implement on public roads without reflectors and slow moving vehicle emblem in daylight and with approved warning lights at night and other periods of poor visibility.
- Keep work area clear of all debris. Never assume an area is clear. ALWAYS CHECK.
- Check to make certain there are no buried utilities in the work area before starting work.
- Keep alert and watch the front as well as the rear when working with the attachment.

OWNER'S/ OPERATOR'S MANUAL

MODEL NO.'s

PSS-620

PSS-720

PSHD-665

PSHD-765

PSHD-865

AUGUST 2013

PIRANHA PSS and PSHD SERIES Powered Landscape Rake

**WHEN ORDERING REPAIR PARTS,
ALWAYS GIVE THE FOLLOWING INFORMATION:**

1. PART NUMBER
2. PART DESCRIPTION
3. MODEL NUMBER
4. NAME OF ITEM



WORKSAVER, INC.

P.O. BOX 100 LITCHFIELD, IL 62056-0100 (217) 324-5973
WEB: <http://www.worksaver.com> E-MAIL: sales@worksaver.com